

MEXDA®

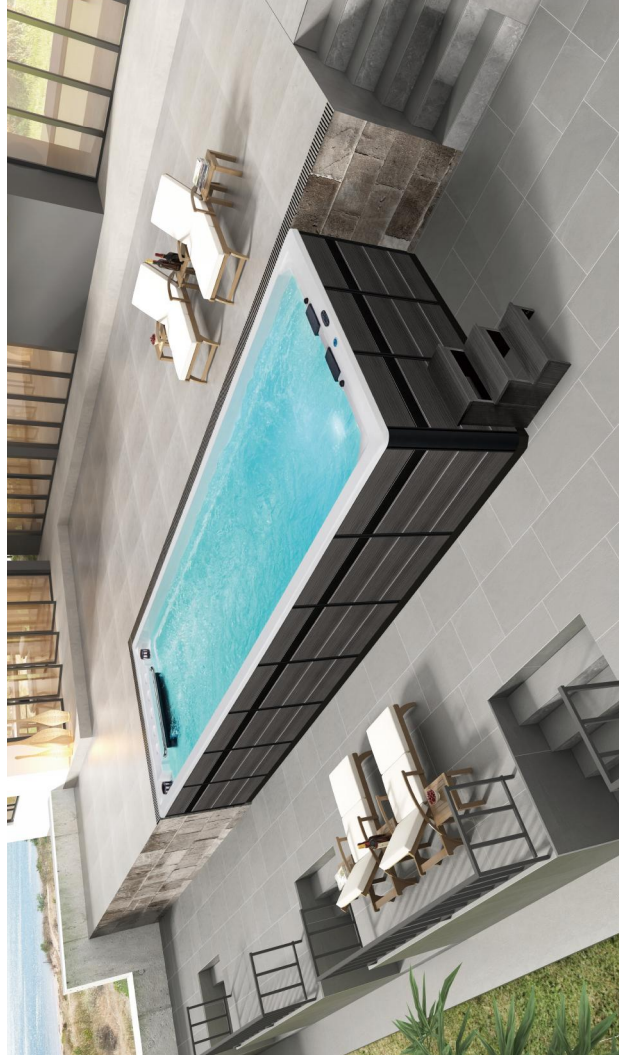

Swim SPA Series

Swim Training System

MEXDA®
万事达® SPA

公司: 佛山市高明粤华卫生洁具有限公司
FOSHAN GAOMING YUEHUA SANITARYWARE CO., LTD.
地址: 中国广东省佛山市高明区杨和镇杨西大道566号
Add: No.568, Yangqi Road, Yanghe Town, Gaoming, Guangdong, China

出口销售 / Export Sales
Tel: (+86 757) 9822272
Tel: (+86 757) 98239778
www.chinamesda.com
mesda.en.alibaba.com



中国销售 / Domestic Sales
Tel: (+86 757) 68227105
Tel: (+86 757) 6822282
Tel: 40008361033
www.mexda.com.cn
https://mexda.rmall.com



INTERNATIONAL
CERTIFICATION
ISO 9001



图中产品的尺寸、配置及标准位置, 可能与实物有所差别, 本公司有权修改或取消上述产品, 恕不另行通知。
The size, configuration and position of parts of the products shown may be different from the actual products, and the
Company reserves the right to modify or cancel the above products without prior notice.

有关工程项目的具体尺寸数据请与厂部联系确认。
For the specific size data of the project, please contact the manufacturer for confirmation.

由于印刷的关系, 正式产品的颜色与所示的图片有部分差异, 产品颜色以实物为准。
Due to the printing, the color of the official product is partially different from the picture shown, and color is subject to the
actual object.



FUNCTIONAL CONFIGURATION

- LED LIGHT
- UV LIGHT
- TEMPERATURE SETTING
- OZONATOR
- WATER JETS
- AIR BUBBLE JET
- WATERFALL
- POP-UP WATERFALL WITH LIGHT

5 reasons to choose Mexda Spa

萬事達SPA五大健康益处

Keep fit 塑身修身

Massage with a bubble massage can help you relax your muscles and reduce stress. It can also help you lose weight and improve your skin. The bubble massage is a great choice for those who want to improve their skin and lose weight.

萬事達SPA的氣泡按摩能幫助您放鬆肌肉，減輕壓力。它還能幫助您減肥並改善您的皮膚。氣泡按摩是那些想要改善皮膚和減肥的人的絕佳選擇。

Skin care 美容美肤

MEXDA SPA provides the best skin care services. Our bubble massage can help you improve your skin and reduce wrinkles. The bubble massage is a great choice for those who want to improve their skin and reduce wrinkles.

MEXDA SPA提供最好的皮膚護理服務。我們的氣泡按摩能幫助您改善您的皮膚並減少皺紋。氣泡按摩是那些想要改善皮膚和減少皺紋的人的絕佳選擇。

Deep clean 深度潔淨

Deep clean is a great way to improve your skin and reduce wrinkles. The bubble massage can help you improve your skin and reduce wrinkles. The bubble massage is a great choice for those who want to improve their skin and reduce wrinkles.

深度清潔是改善您的皮膚並減少皺紋的好方法。氣泡按摩能幫助您改善您的皮膚並減少皺紋。氣泡按摩是那些想要改善皮膚和減少皺紋的人的絕佳選擇。

Health treatments 保健SPA

Health treatments are a great way to improve your skin and reduce wrinkles. The bubble massage can help you improve your skin and reduce wrinkles. The bubble massage is a great choice for those who want to improve their skin and reduce wrinkles.

保健SPA是改善您的皮膚並減少皺紋的好方法。氣泡按摩能幫助您改善您的皮膚並減少皺紋。氣泡按摩是那些想要改善皮膚和減少皺紋的人的絕佳選擇。

Renew spirit 恢復活力

Renew spirit is a great way to improve your skin and reduce wrinkles. The bubble massage can help you improve your skin and reduce wrinkles. The bubble massage is a great choice for those who want to improve their skin and reduce wrinkles.

恢復活力是改善您的皮膚並減少皺紋的好方法。氣泡按摩能幫助您改善您的皮膚並減少皺紋。氣泡按摩是那些想要改善皮膚和減少皺紋的人的絕佳選擇。

The bigger the better 大吧美乐的沐浴

The bigger the better is a great way to improve your skin and reduce wrinkles. The bubble massage can help you improve your skin and reduce wrinkles. The bubble massage is a great choice for those who want to improve their skin and reduce wrinkles.

大吧美乐的沐浴是改善您的皮膚並減少皺紋的好方法。氣泡按摩能幫助您改善您的皮膚並減少皺紋。氣泡按摩是那些想要改善皮膚和減少皺紋的人的絕佳選擇。

Lovely designs 人工人室內設計

Lovely designs are a great way to improve your skin and reduce wrinkles. The bubble massage can help you improve your skin and reduce wrinkles. The bubble massage is a great choice for those who want to improve their skin and reduce wrinkles.

人工人室內設計是改善您的皮膚並減少皺紋的好方法。氣泡按摩能幫助您改善您的皮膚並減少皺紋。氣泡按摩是那些想要改善皮膚和減少皺紋的人的絕佳選擇。

Message experience, the only in the world 前所未有按摩體驗

Message experience is a great way to improve your skin and reduce wrinkles. The bubble massage can help you improve your skin and reduce wrinkles. The bubble massage is a great choice for those who want to improve their skin and reduce wrinkles.

前所未有按摩體驗是改善您的皮膚並減少皺紋的好方法。氣泡按摩能幫助您改善您的皮膚並減少皺紋。氣泡按摩是那些想要改善皮膚和減少皺紋的人的絕佳選擇。

Incomparable enjoyment 无与伦比的享受

Incomparable enjoyment is a great way to improve your skin and reduce wrinkles. The bubble massage can help you improve your skin and reduce wrinkles. The bubble massage is a great choice for those who want to improve their skin and reduce wrinkles.

无与伦比的享受是改善您的皮膚並減少皺紋的好方法。氣泡按摩能幫助您改善您的皮膚並減少皺紋。氣泡按摩是那些想要改善皮膚和減少皺紋的人的絕佳選擇。



12-10m

| P01 | |
|---------------|-----|
| WS-130C III | P01 |
| WS-130C III-U | P02 |
| WS-S12-T | P03 |
| WS-S12 | P04 |
| WS-130B III | P05 |
| WS-130B III-U | P06 |
| WS-S10-T | P07 |
| WS-S10 | P08 |

8-7m

| P09 | |
|---------------|-----|
| WS-130A III | P09 |
| WS-130A III-U | P10 |
| WS-PC08U | P11 |
| WS-PC08T | P12 |
| WS-S08M | P13 |
| WS-PC08ST | P14 |
| WS-S08T1 | P15 |
| WS-S08T2 | P16 |
| WS-S08CT | P17 |
| WS-S08B | P18 |
| WS-S07M | P19 |
| WS-PC07A-T | P20 |
| WS-PC07A | P21 |
| WS-PC07ST | P22 |
| WS-PC07ST-S | P23 |
| WS-S07B | P24 |

6-5m

| P25 | |
|---------------|-----|
| WS-SP600 | P25 |
| WS-SP600-MS | P26 |
| WS-PC06T | P27 |
| WS-S06 | P28 |
| WS-S06C | P29 |
| WS-S06CT | P30 |
| WS-S06B | P31 |
| WS-S06B-T | P32 |
| WS-S06M | P33 |
| WS-PC06ST | P34 |
| WS-PC06CH | P35 |
| WS-SP500 | P36 |
| WS-SP500-MS | P37 |
| WS-125A III | P38 |
| WS-125A III-U | P39 |
| WS-115E III-U | P40 |
| WS-115F III | P41 |
| WS-PC05CH | P42 |
| WS-PC05 | P43 |
| WS-PC05ST | P44 |
| WS-PC05ST-S | P45 |

4-3m

| P46 | |
|---------------|-----|
| WS-115A III | P46 |
| WS-115A III-U | P47 |
| WS-S04 | P48 |
| WS-S04X | P49 |
| WS-S04B | P50 |
| WS-S38 | P51 |
| WS-PC04CH | P52 |
| WS-P001 | P53 |
| WS-PC01A | P54 |
| WS-PC01 | P55 |
| WS-PC02 | P56 |
| WS-PC03 | P57 |

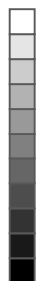
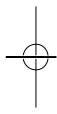
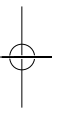

WS-130C III

Size: 11830x3000x1430mm



WATER JETS TEMPERATURE SETTING LED LIGHT OZONE

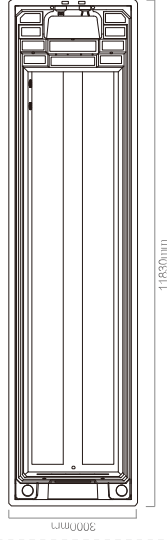

Product Detail

| | | | |
|-----------------------|---------|---------|---------|
| Control system: | 1 set | 控制系统: | 1套 |
| Swim training system: | 1 set | 游泳训练系统: | 1套 |
| Water pump: | 1 pc | 水泵: | 1台 |
| Filter pump: | 1 pc | 过滤泵: | 1台 |
| Jet total: | 20 pcs | 喷嘴总数: | 20个 |
| LED: | 7 pcs | 池底灯: | 7个 |
| Total power: | 10.85kW | 总功率: | 10.85kW |



WS-130C III-U

Size: 11830x3000x1430mm



WATER JETS TEMPERATURE SETTING LED LIGHT OZONE

Product Detail

| | | | |
|-----------------|---------|-------|---------|
| Control system: | 1 set | 控制系统: | 1套 |
| Water pump: | 4 pcs | 水泵: | 4台 |
| Filter pump: | 1 pc | 过滤泵: | 1台 |
| Jet total: | 23 pcs | 喷嘴总数: | 23个 |
| LED: | 5 pcs | 池底灯: | 5个 |
| Total power: | 11.85kW | 总功率: | 11.85kW |

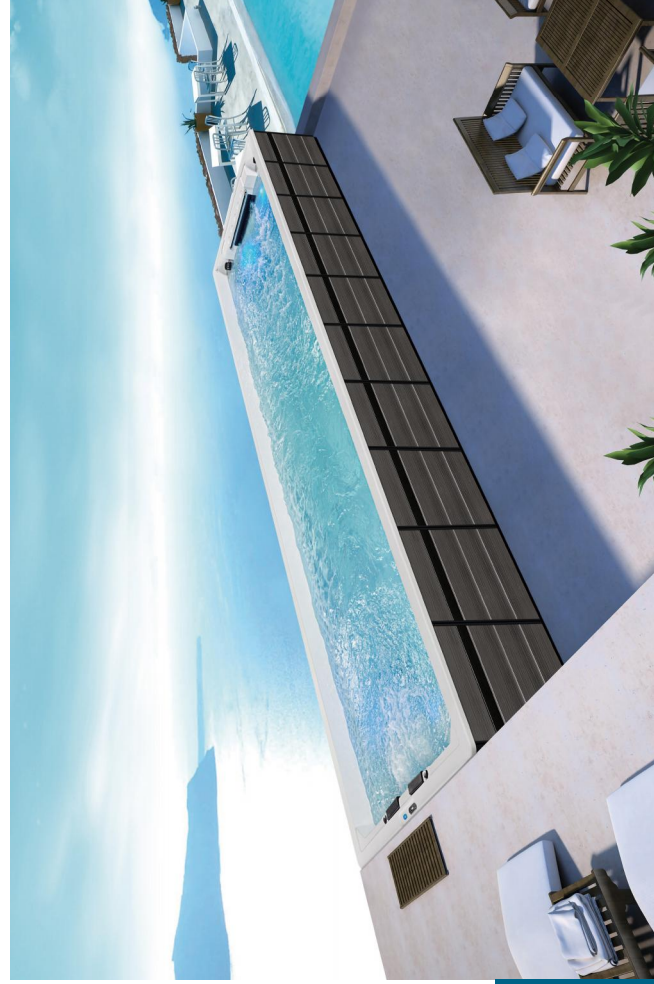
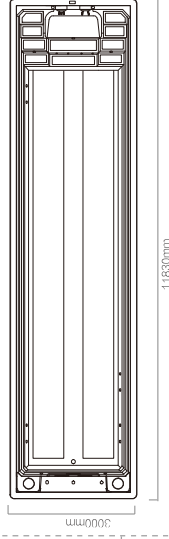



WS-S12

Size: 11740x2200x1470mm



WATER JETS | TEMPERATURE SETTING | LED LIGHT | OZONE

Product Detail

Message Pool / 按摩池

| | | | |
|-----------------|--------|-------|--------|
| Control system: | 1 set | 控制系统: | 1 套 |
| Water pump: | 2 pcs | 水泵: | 2 台 |
| Filter pump: | 1 pc | 过滤器: | 1 台 |
| Jet total: | 73 pcs | 喷嘴总数: | 73 个 |
| Led: | 1 pc | 池底灯: | 1 个 |
| Total power: | 7.65KW | 总功率: | 7.65KW |

Swimming Pool / 游泳池

| | | | |
|-----------------|--------|-------|--------|
| Control system: | 1 set | 控制系统: | 1 套 |
| Water pump: | 3 pcs | 水泵: | 3 台 |
| Filter pump: | 2 pcs | 过滤器: | 2 台 |
| Jet total: | 36 pcs | 喷嘴总数: | 36 个 |
| Led: | 6 pcs | 池底灯: | 6 个 |
| Small led: | 50 pcs | 小灯珠: | 50 个 |
| Total power: | 14.1kW | 总功率: | 14.1kW |

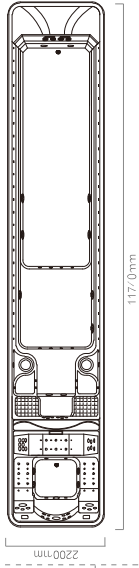

WS-S12-T

Size: 11740x2200x1470mm

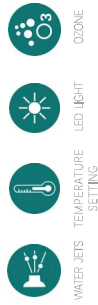

WATER JETS | TEMPERATURE SETTING | LED LIGHT | OZONE

Product Detail

Message Pool / 按摩池

| | | | |
|-----------------|--------|-------|--------|
| Control system: | 1 set | 控制系统: | 1 套 |
| Water pump: | 2 pcs | 水泵: | 2 台 |
| Filter pump: | 1 pc | 过滤器: | 1 台 |
| Jet total: | 73 pcs | 喷嘴总数: | 73 个 |
| Led: | 1 pc | 池底灯: | 1 个 |
| Total power: | 7.65KW | 总功率: | 7.65KW |

Swimming Pool / 游泳池

| | | | |
|-----------------------|--------|---------|-------|
| Control system: | 1 set | 控制系统: | 1 套 |
| Swim training system: | 1 set | 游泳训练系统: | 1 套 |
| Water pump: | 1 pc | 水泵: | 1 台 |
| Filter pump: | 2 pcs | 过滤器: | 2 台 |
| Jet total: | 28 pcs | 喷嘴总数: | 28 个 |
| Led: | 6 pcs | 池底灯: | 6 个 |
| Small led: | 50 pcs | 小灯珠: | 50 个 |
| Total power: | 9.5KW | 总功率: | 9.5KW |

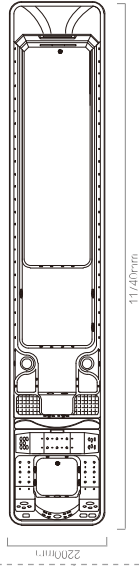

WS-130B III

Size: 9950x3000x1430mm



WATER JETS TEMPERATURE SETTING LED LIGHT OZONE

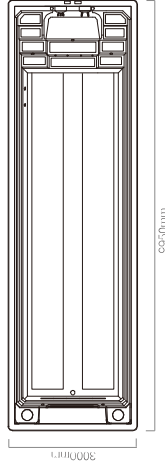

9950mm

3000mm

Product Detail

| | | | |
|-----------------------|---------|---------|---------|
| Control system: | 1 set | 控制系统: | 1套 |
| Swim training system: | 1 set | 游泳训练系统: | 1套 |
| Water pump: | 1 pc | 水泵: | 1台 |
| Filter pump: | 1 pc | 过滤器: | 1台 |
| Jet total: | 20 pcs | 喷嘴总数: | 20个 |
| LED: | 7 pcs | 池底灯: | 7个 |
| Total power: | 10.85kW | 总功率: | 10.85kW |



WS-130B III-U

Size: 9950x3000x1430mm



WATER JETS TEMPERATURE SETTING LED LIGHT OZONE

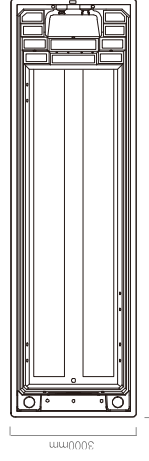

9950mm

3000mm

Product Detail

| | | | |
|-----------------|---------|-------|---------|
| Control system: | 1 set | 控制系统: | 1套 |
| Water pump: | 4 pcs | 水泵: | 4台 |
| Filter pump: | 1 pc | 过滤器: | 1台 |
| Jet total: | 23 pcs | 喷嘴总数: | 23个 |
| LED: | 5 pcs | 池底灯: | 5个 |
| Total power: | 11.85kW | 总功率: | 11.85kW |





WS-S10-T

Size: 10000x2200x1450mm



WATER JETS TEMPERATURE SETTING LED LIGHT OZONE

Product Detail

| Message Pool / 按摩池 | |
|--------------------|----------------------|
| Control system: | 1 set 控制系统: 1套 |
| Water pump: | 2 pcs 水泵: 2台 |
| Filter pump: | 1 pc 过滤器: 1台 |
| Jet total: | 76 pcs 喷嘴总数: 76个 |
| LED: | 1 pc 池底灯: 1个 |
| Total power: | 7.65kW 总功率: 7.65kW |

Swimming Pool / 游泳池

| | |
|-----------------------|--------------------|
| Control system: | 1 set 控制系统: 1套 |
| Swim training system: | 1 set 游泳训练系统: 1套 |
| Water pump: | 1 pc 水泵: 1台 |
| Filter pump: | 2 pcs 过滤器: 2台 |
| Jet total: | 34 pcs 喷嘴总数: 34个 |
| LED: | 4 pcs 池底灯: 4个 |
| Small led: | 40 pcs 小灯珠: 40个 |
| Total power: | 8.8kW 总功率: 8.8kW |

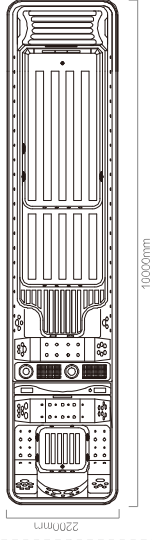

MEXIDA 07

WS-S10

Size: 10000x2200x1450mm



WATER JETS TEMPERATURE SETTING LED LIGHT OZONE

Product Detail

| Message Pool / 按摩池 | |
|--------------------|----------------------|
| Control system: | 1 set 控制系统: 1套 |
| Water pump: | 2 pcs 水泵: 2台 |
| Filter pump: | 1 pc 过滤器: 1台 |
| Jet total: | 76 pcs 喷嘴总数: 76个 |
| LED: | 1 pc 池底灯: 1个 |
| Total power: | 7.65kW 总功率: 7.65kW |

Swimming Pool / 游泳池

| | |
|-----------------|----------------------|
| Control system: | 1 set 控制系统: 1套 |
| Water pump: | 4 pcs 水泵: 4台 |
| Filter pump: | 2 pcs 过滤器: 2台 |
| Jet total: | 40 pcs 喷嘴总数: 40个 |
| LED: | 4 pcs 池底灯: 4个 |
| Small led: | 40 pcs 小灯珠: 40个 |
| Total power: | 12.6kW 总功率: 12.6kW |

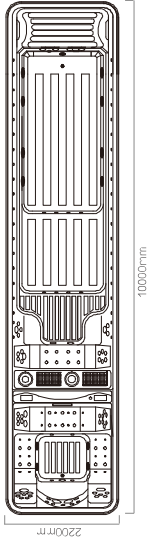

MEXIDA 08

WS-130A III

Size: 7960x2980x1400mm



WATER JETS TEMPERATURE SETTING LED LIGHT OZONE

Product Detail

| | | | |
|-----------------------|---------|---------|---------|
| Control system: | 1 set | 控制系统: | 1套 |
| Swim training system: | 1 set | 游泳训练系统: | 1套 |
| Water pump: | 1 pc | 水泵: | 1台 |
| Filter pump: | 1 pc | 过滤器: | 1台 |
| Jet total: | 20 pcs | 喷嘴总数: | 20个 |
| LED: | 7 pcs | 池底灯: | 7个 |
| Total power: | 10.85kW | 总功率: | 10.85kW |

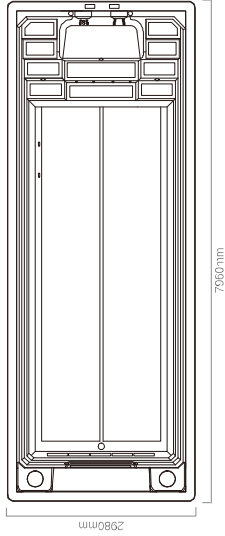

MEXDA 09

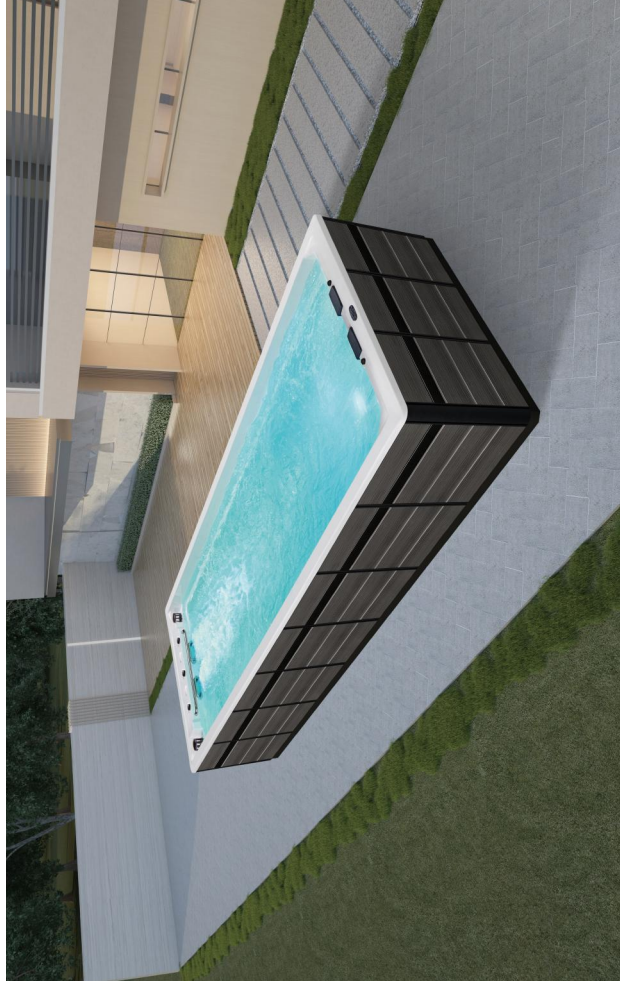

WS-130A III-U

Size: 7960x2980x1400mm



WATER JETS TEMPERATURE SETTING LED LIGHT OZONE

Product Detail

| | | | |
|-----------------|---------|-------|---------|
| Control system: | 1 set | 控制系统: | 1套 |
| Water pump: | 4 pcs | 水泵: | 4台 |
| Filter pump: | 1 pc | 过滤器: | 1台 |
| Jet total: | 23 pcs | 喷嘴总数: | 23个 |
| LED: | 5 pcs | 池底灯: | 5个 |
| Total power: | 11.85kW | 总功率: | 11.85kW |

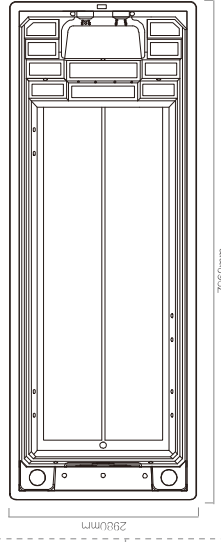

MEXDA 10

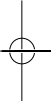

WS-PC08T

Size: 8000x3000x1500mm



WATER JETS



LED LIGHT



OZONE

Product Detail

| | | | |
|-----------------------|---------|---------|---------|
| Control system: | 1 set | 控制系统: | 1套 |
| Swim training system: | 1 set | 游泳训练系统: | 1套 |
| Water pump: | 1 pc | 水泵: | 1台 |
| Filter pump: | 1 pc | 过滤泵: | 1台 |
| Jet total: | 28 pcs | 喷嘴总数: | 28个 |
| LED: | 3 pcs | 池底灯: | 3个 |
| Total power: | 10.85kW | 总功率: | 10.85kW |

WS-PC08U

Size: 8000x3000x1500mm



WATER JETS



TEMPERATURE SETTING



LED LIGHT



OZONE

Product Detail

| | | | |
|-----------------|---------|-------|---------|
| Control system: | 1 set | 控制系统: | 1套 |
| Water pump: | 4 pcs | 水泵: | 4台 |
| Filter pump: | 1 pc | 过滤泵: | 1台 |
| Jet total: | 33 pcs | 喷嘴总数: | 33个 |
| LED: | 1 pc | 池底灯: | 1个 |
| Total power: | 11.85kW | 总功率: | 11.85kW |



WS-S08M

Size: 8020x2260x1280mm



WATER JETS TEMPERATURE SETTING LED LIGHT OZONE

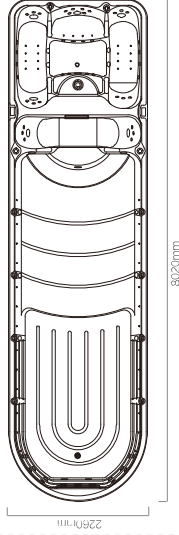

Product Detail

Message Pool / 按摩池

| | | | |
|-----------------|--------|-------|--------|
| Control system: | 1 set | 控制系统: | 1 套 |
| Water pump: | 2 pcs | 水泵: | 2 台 |
| Filter pump: | 1 pc | 过滤器: | 1 台 |
| Jet total: | 58 pcs | 喷嘴总数: | 58 个 |
| LED: | 1 pc | 池底灯: | 1 个 |
| Total power: | 6.95kW | 总功率: | 6.95kW |

Swimming Pool / 游泳池

| | | | |
|-----------------|--------|-------|--------|
| Control system: | 1 set | 控制系统: | 1 套 |
| Water pump: | 3 pcs | 水泵: | 3 台 |
| Filter pump: | 1 pc | 过滤器: | 1 台 |
| Jet total: | 36 pcs | 喷嘴总数: | 36 个 |
| LED: | 3 pcs | 池底灯: | 3 个 |
| Small led: | 26 pcs | 小灯珠: | 26 个 |
| Total power: | 9.65kW | 总功率: | 9.65kW |

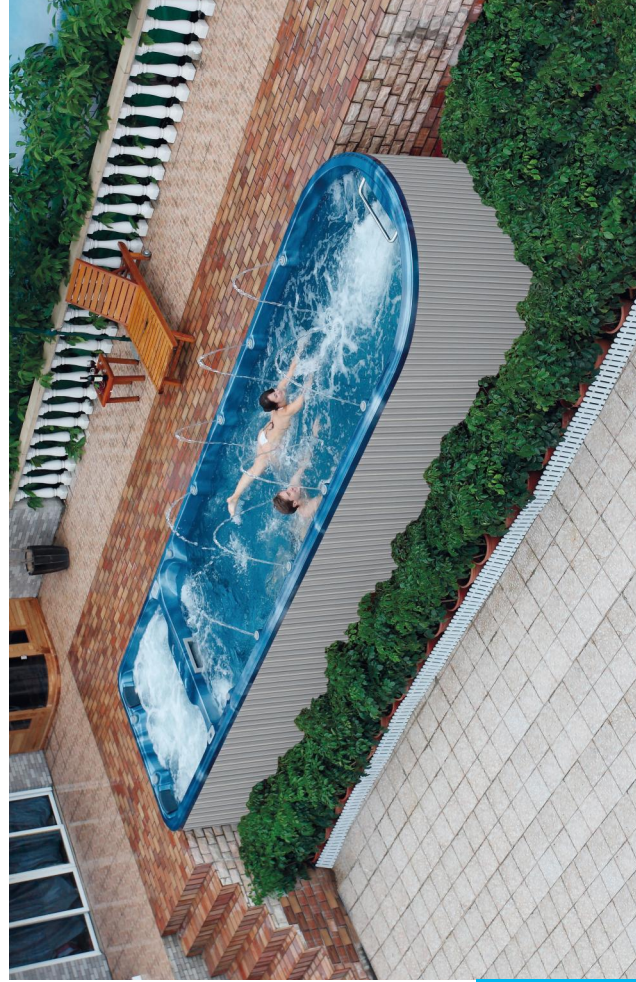

WS-PC08ST

Size: 8000x2400x1470mm



WATER JETS TEMPERATURE SETTING LED LIGHT OZONE

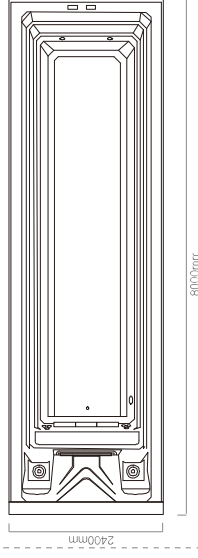

Product Detail

| | | | |
|-----------------------|--------|---------|--------|
| Control system: | 1 set | 控制系统: | 1 套 |
| Swim training system: | 1 set | 游泳训练系统: | 1 套 |
| Filter pump: | 1 pc | 过滤器: | 1 台 |
| Jet total: | 6 pcs | 喷嘴总数: | 6 个 |
| LED: | 4 pcs | 池底灯: | 4 个 |
| Total power: | 6.55kW | 总功率: | 6.55kW |



▲ WS-S08T1

WS-S08T1、WS-S08T2

Size: (WS-S08T1) 7800x2200x1500mm
(WS-S08T2) 7800x2200x1500mm



WATER JETS LED LIGHT OZONE

Product Detail

| | | | |
|-----------------------|--------|---------|--------|
| Control system: | 1 set | 控制系统: | 1套 |
| Swim training system: | 1 set | 游泳训练系统: | 1套 |
| Water pump: | 2 pcs | 水泵: | 2台 |
| Filter pump: | 1 pc | 过滤器: | 1台 |
| Jet total: | 50 pcs | 喷嘴总数: | 50个 |
| Leads: | 4 pcs | 池底灯: | 4个 |
| Small led: | 28 pcs | 小灯珠: | 28个 |
| Total power: | 9.55kW | 总功率: | 9.55kW |

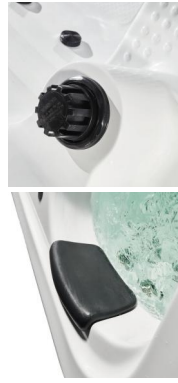

WS-S08CT

Size: 8000x2400x1420mm



WATER JETS TEMPERATURE SETTING LED LIGHT OZONE

Product Detail

| | | | |
|-----------------------|--------|---------|--------|
| Control system: | 1 set | 控制系统: | 1套 |
| Swim training system: | 1 set | 游泳训练系统: | 1套 |
| Water pump: | 1 pc | 水泵: | 1台 |
| Filter pump: | 1 pc | 过滤器: | 1台 |
| Jet total: | 31 pcs | 喷嘴总数: | 31个 |
| Leads: | 6 pcs | 池底灯: | 6个 |
| Total power: | 8.35kW | 总功率: | 8.35kW |

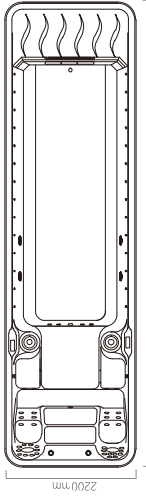
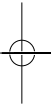
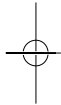
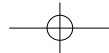
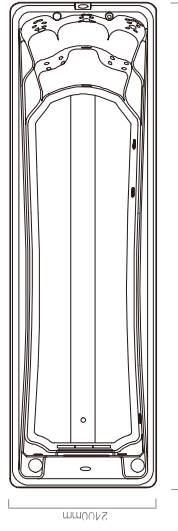

▼ WS-S08T1



▼ WS-S08T1

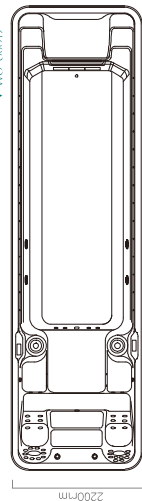

▼ WS-S08T2



▼ WS-S08T2

WS-S08B

Size: 7800x2200x11500mm



Product Detail

| | | | |
|-----------------|--------|-------|--------|
| Control system: | 2 set | 控制系统: | 2 套 |
| Water pump: | 4 pcs | 水泵: | 4 台 |
| Filter pump: | 2 pcs | 过滤器: | 2 台 |
| Jet total: | 98 pcs | 喷嘴总数: | 98 个 |
| LED: | 7 pcs | 池底灯: | 7 个 |
| Small jet: | 46 pcs | 小灯珠: | 46 个 |
| Total power: | 14.6kW | 总功率: | 14.6kW |

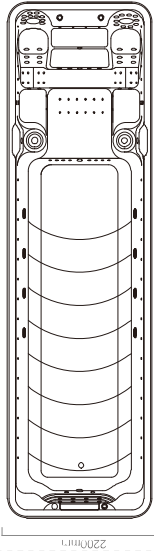

7800mm



MEXDA 17



WS-S07M

Size: 7000x2200x1480mm

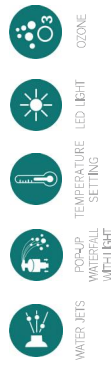

Product Detail

| | | | |
|------------------------------|---------|---------|---------|
| Control system: | 1 set | 控制系统: | 1 套 |
| Water pump: | 3 pcs | 水泵: | 3 台 |
| Filter pump: | 1 pc | 过滤器: | 1 台 |
| Jet total: | 40 pcs | 喷嘴总数: | 40 个 |
| water column: | 4 pcs | 喷水柱: | 4 个 |
| Pop-up waterfall with light: | 2 pcs | 带灯升降喷泉: | 2 个 |
| LED: | 2 pcs | 池底灯: | 2 个 |
| Total power: | 10.75kW | 总功率: | 10.75kW |

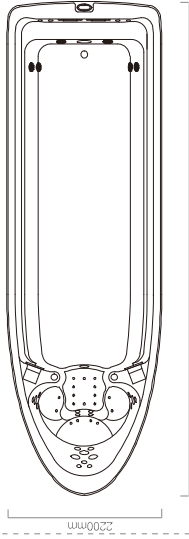

7000mm



MEXDA 18



WS-PC07A-T

Size: 7000x3000x1470mm



Product Detail

| | | | |
|-----------------------|---------|---------|---------|
| Control system: | 1 set | 控制系统: | 1套 |
| Swim training system: | 1 set | 游泳训练系统: | 1套 |
| Water pump: | 1 pc | 水泵: | 1台 |
| Filter pump: | 1 pc | 过滤器: | 1台 |
| Jet total: | 50 pcs | 喷嘴总数: | 50个 |
| Led: | 4 pcs | 池底灯: | 4个 |
| Total power: | 11.55kW | 总功率: | 11.55kW |

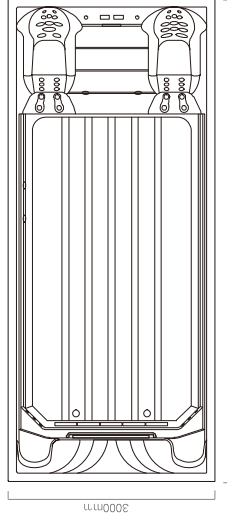

7000mm



WS-PC07A

Size: 7000x3000x1470mm



Product Detail

| | | | |
|-----------------|--------|-------|--------|
| Control system: | 1 set | 控制系统: | 1套 |
| Water pump: | 4 pcs | 水泵: | 4台 |
| Filter pump: | 1 pc | 过滤器: | 1台 |
| U shape jet: | 1 pc | 特大喷嘴: | 1个 |
| Jet total: | 50 pcs | 喷嘴总数: | 50个 |
| Led: | 1 pc | 池底灯: | 1个 |
| Total power: | 9.55kW | 总功率: | 9.55kW |

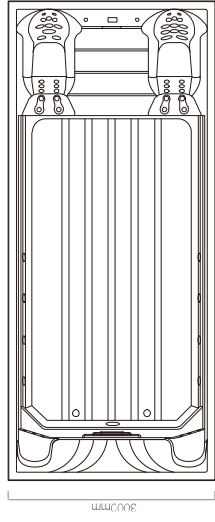

7000mm

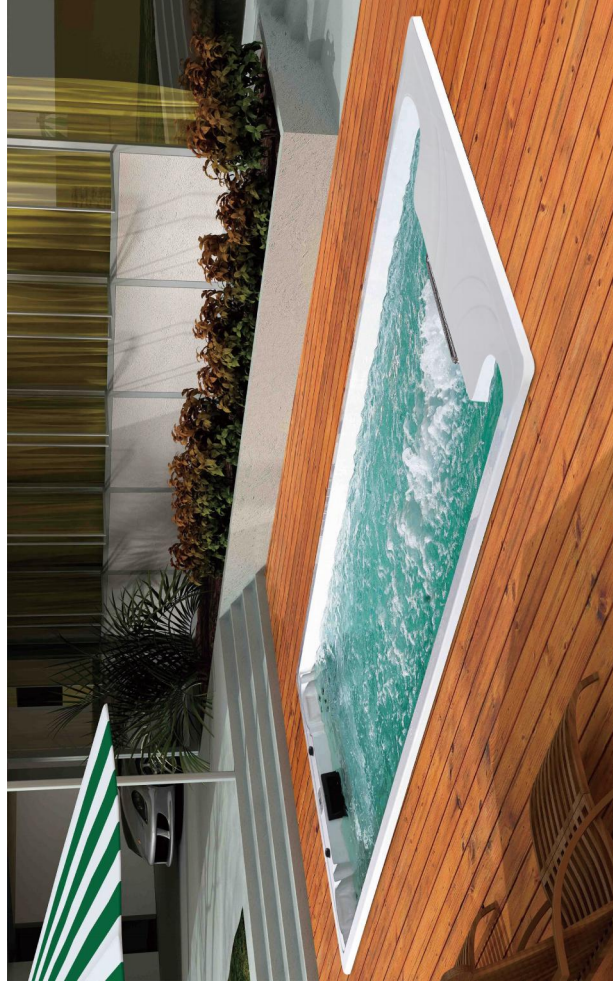

WS-PC07ST

Size: 7000x2400x1470mm



WATER JETS



TEMPERATURE SETTING



LED LIGHT



OZONE

Product Detail

| | | | |
|-----------------------|--------|---------|--------|
| Control system: | 1 set | 控制系统: | 1套 |
| Swim training system: | 1 set | 游泳训练系统: | 1套 |
| Filter pump: | 1 pc | 过滤器: | 1台 |
| Jet total: | 6 pcs | 喷嘴总数: | 6个 |
| LED: | 4 pcs | 池底灯: | 4个 |
| Total power: | 6.55kW | 总功率: | 6.55kW |

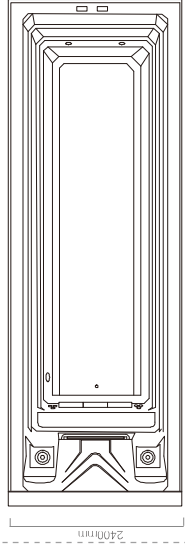

7000mm



MEXDA 21



Automatic Swimmingpool Cover

Size: 7000x2400x1470mm

WS-PC07ST-S



WATER JETS



TEMPERATURE SETTING



LED LIGHT



OZONE

Product Detail

| | | | |
|-----------------------|--------|---------|--------|
| Control system: | 1 set | 控制系统: | 1套 |
| Swim training system: | 1 set | 游泳训练系统: | 1套 |
| Filter pump: | 1 pc | 过滤器: | 1台 |
| Jet total: | 6 pcs | 喷嘴总数: | 6个 |
| LED: | 4 pcs | 池底灯: | 4个 |
| Total power: | 6.55kW | 总功率: | 6.55kW |

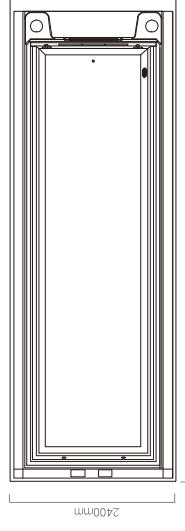

7000mm



*Automatic Swimmingpool Cover is extra option

MEXDA 22

WS-S07B

Size: 7000x2200x1335mm

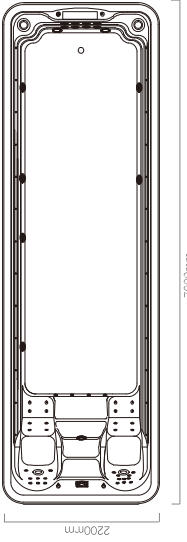

7000mm

Product Detail

| | | | |
|-----------------|---------|-------|---------|
| Control system: | 1 set | 控制系统: | 1套 |
| Water pump: | 3 pcs | 水 泵: | 3台 |
| Filter pump: | 1 pc | 过滤泵: | 1台 |
| Jet total: | 48 pcs | 喷嘴总数: | 48个 |
| LED: | 3 pcs | 池底灯: | 3个 |
| Small led: | 26 pcs | 小灯珠: | 26个 |
| Total power: | 13.35kW | 总功率: | 13.35kW |

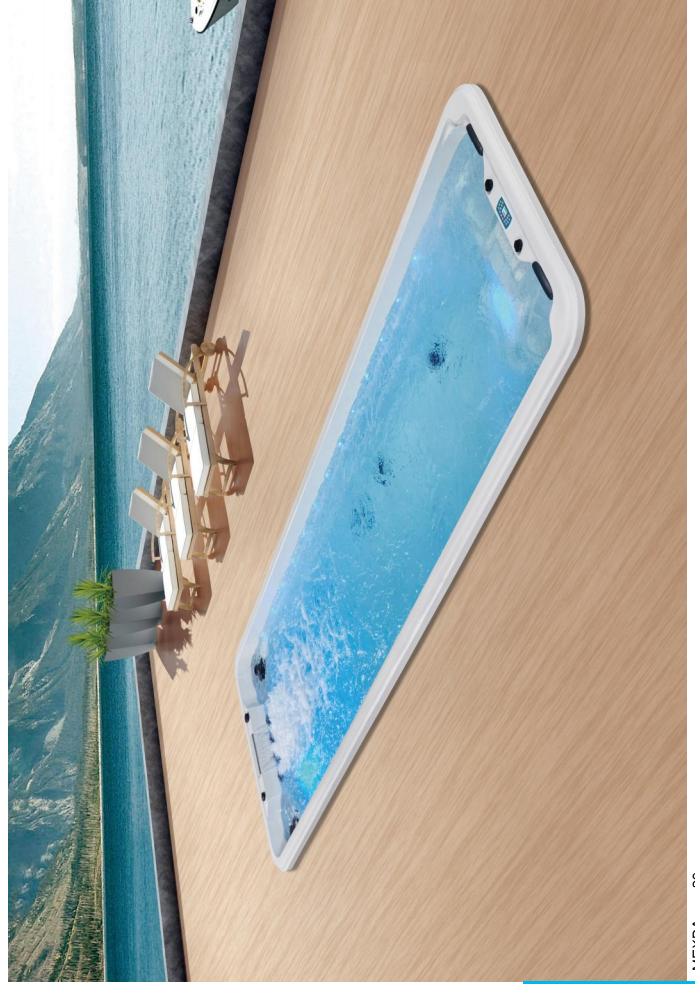

WS-S07B-T

Size: 7000x2200x1365mm

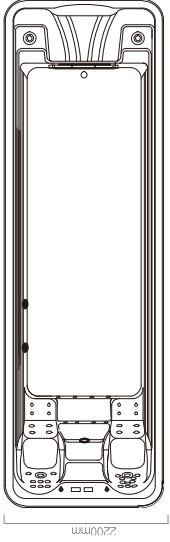

7000mm

Product Detail

| | | | |
|-----------------------|--------|---------|--------|
| Control system: | 1 set | 控制系统: | 1套 |
| Swim training system: | 1 set | 游泳训练系统: | 1套 |
| Water pump: | 1 pc | 水 泵: | 1台 |
| Filter pump: | 1 pc | 过滤泵: | 1台 |
| Jet total: | 44 pcs | 喷嘴总数: | 44个 |
| LED: | 3 pcs | 池底灯: | 3个 |
| Small led: | 26 pcs | 小灯珠: | 26个 |
| Total power: | 8.75kW | 总功率: | 8.75kW |

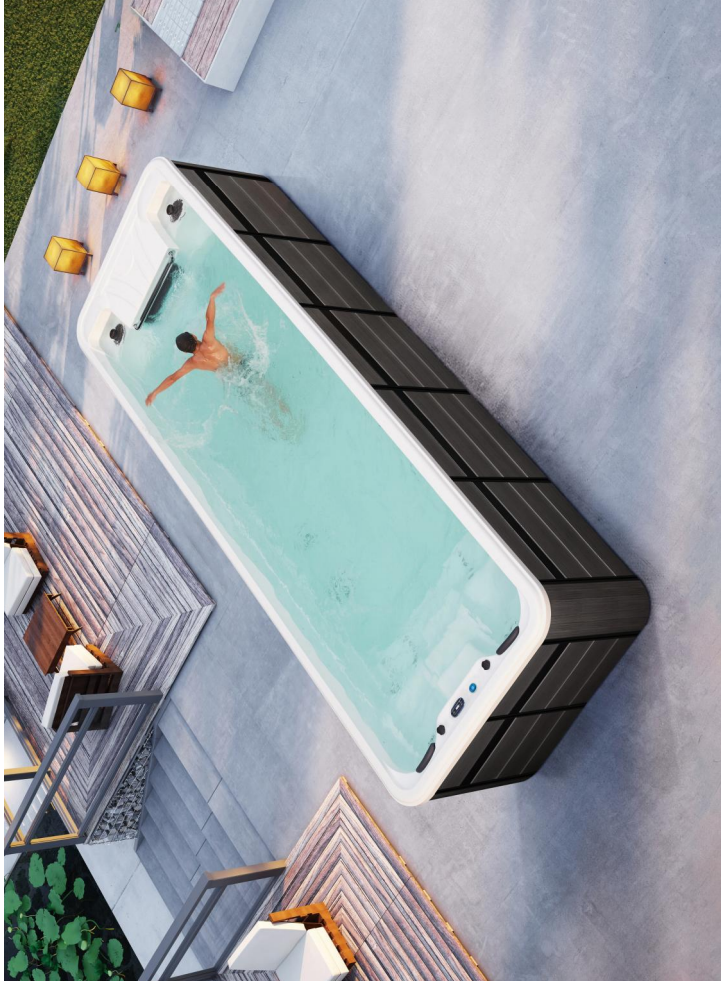



WS-SP600

Size: 5900x2500x1600mm



WATER JETS



TEMPERATURE SETTING



LED LIGHT



OZONE

Product Detail

| | | | |
|-----------------------|--------|---------|--------|
| Control system: | 1 set | 控制系统: | 1套 |
| Swim training system: | 1 set | 游泳训练系统: | 1套 |
| Filter pump: | 1 pc | 过滤器: | 1台 |
| Jet total: | 6 pcs | 喷嘴总数: | 6个 |
| LED: | 4 pcs | 池底灯: | 4个 |
| Total power: | 9.35kW | 总功率: | 9.35kW |

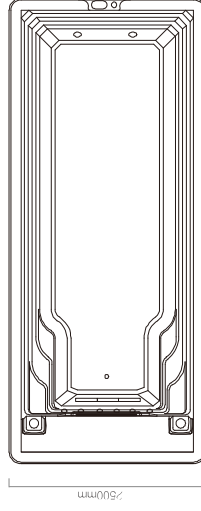

5900mm



WS-SP600-MS

Size: 5900x2500x1600mm



WATER JETS



TEMPERATURE SETTING



LED LIGHT



OZONE

Product Detail

| | | | |
|-----------------------|---------|---------|---------|
| Control system: | 1 set | 控制系统: | 1套 |
| Swim training system: | 1 set | 游泳训练系统: | 1套 |
| Water pump: | 1 pc | 水泵: | 1台 |
| Filter pump: | 1 pc | 过滤器: | 1台 |
| Jet total: | 29 pcs | 喷嘴总数: | 29个 |
| LED: | 4 pcs | 池底灯: | 4个 |
| Total power: | 11.55kW | 总功率: | 11.55kW |

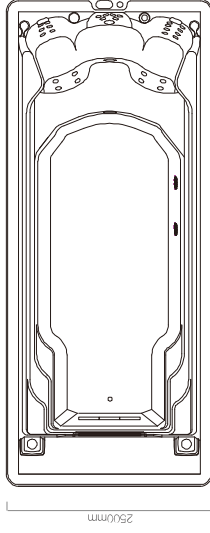

5900mm



WS-PC06T

Size: 5800x3000x1500mm



Product Detail

| | | | |
|-----------------------|---------|---------|---------|
| Control system: | 1 set | 控制系统: | 1 套 |
| Swim training system: | 1 set | 游泳训练系统: | 1 套 |
| Water pump: | 1 pc | 水泵: | 1 台 |
| Filter pump: | 1 pc | 过滤器: | 1 台 |
| Jet total: | 19 pcs | 喷嘴总数: | 19 个 |
| Led: | 3 pcs | 池底灯: | 3 个 |
| Total power: | 10.85kW | 总功率: | 10.85kW |

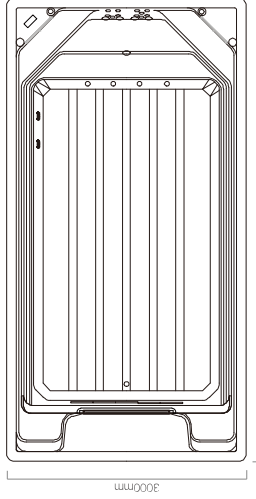

WS-S06

Size: 5620x2220x1110mm



Product Detail

| Message Pool / 按摩池 | | | |
|---------------------|--------|-------|--------|
| Control system: | 1 set | 控制系统: | 1 套 |
| Water pump: | 2 pcs | 水泵: | 2 台 |
| Filter pump: | 1 pc | 过滤器: | 1 台 |
| Jet total: | 56 pcs | 喷嘴总数: | 56 个 |
| Led: | 2 pcs | 池底灯: | 2 个 |
| Total power: | 6.35kW | 总功率: | 6.35kW |
| Swimming Pool / 游泳池 | | | |
| Control system: | 1 set | 控制系统: | 1 套 |
| Water pump: | 2 pcs | 水泵: | 2 台 |
| Filter pump: | 1 pc | 过滤器: | 1 台 |
| Jet total: | 23 pcs | 喷嘴总数: | 23 个 |
| water column: | 4 pcs | 喷水柱: | 4 个 |
| Small led: | 18 pcs | 小灯珠: | 18 个 |
| Led: | 3 pcs | 池底灯: | 3 个 |
| Total power: | 7.45kW | 总功率: | 7.45kW |

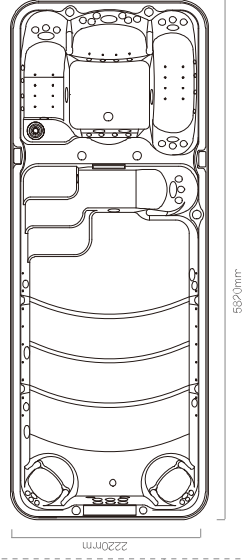



WS-S06CT

Size: 5880x2380x1400mm



WATER JETS TEMPERATURE LED LIGHT SETTING OZONE

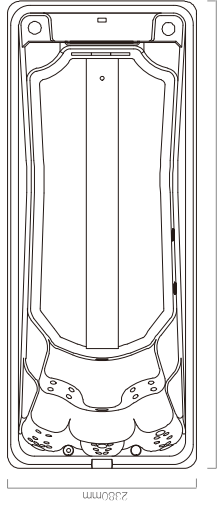

Product Detail

| | | | |
|-----------------------|--------|---------|--------|
| Control system: | 1 set | 控制系统: | 1套 |
| Swim training system: | 1 set | 游泳训练系统: | 1套 |
| Water pump: | 1 pc | 水泵: | 1台 |
| Filter pump: | 1 pc | 过滤器: | 1台 |
| Jet total: | 31 pcs | 喷嘴总数: | 31个 |
| LED: | 4 pcs | 池底灯: | 4个 |
| Total power: | 8.35kW | 总功率: | 8.35kW |

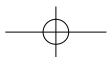

WS-S06C

Size: 5880x2380x1400mm



WATER JETS TEMPERATURE LED LIGHT SETTING OZONE

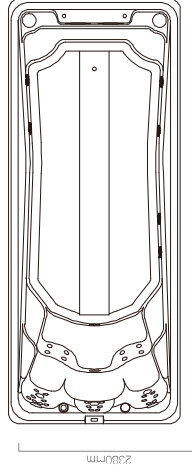

Product Detail

| | | | |
|-----------------|--------|-------|--------|
| Control system: | 1 set | 控制系统: | 1套 |
| Water pump: | 3 pcs | 水泵: | 3台 |
| Filter pump: | 1 pc | 过滤器: | 1台 |
| Jet total: | 33 pcs | 喷嘴总数: | 33个 |
| LED: | 2 pcs | 池底灯: | 2个 |
| Total power: | 9.95kW | 总功率: | 9.95kW |

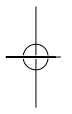

WS-S06B

Size: 5800x2200x1250mm

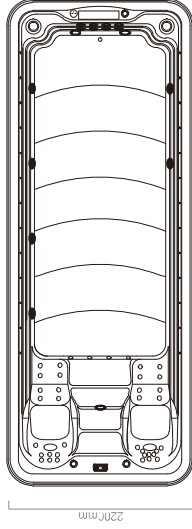
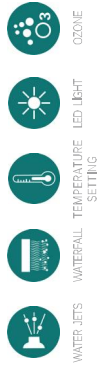

5800mm

Product Detail

| | | | |
|-----------------|---------|-------|---------|
| Control system: | 1 set | 控制系统: | 1套 |
| Water pump: | 3 pcs | 水泵: | 3台 |
| Filter pump: | 1 pc | 过滤器: | 1台 |
| Jet total: | 48 pcs | 喷嘴总数: | 48个 |
| LED: | 3 pcs | 池底灯: | 3个 |
| Small led: | 26 pcs | 小灯珠: | 26个 |
| Total power: | 13.35kW | 总功率: | 13.35kW |



MEXDA 31



WS-S06B-T

Size: 5800x2200x1400mm

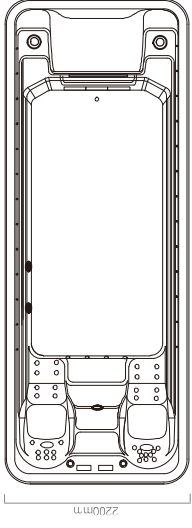

5800mm



Product Detail

| | | | |
|-----------------------|--------|---------|--------|
| Control system: | 1 set | 控制系统: | 1套 |
| Swim training system: | 1 set | 游泳训练系统: | 1套 |
| Water pump: | 1 pc | 水泵: | 1台 |
| Filter pump: | 1 pc | 过滤器: | 1台 |
| Jet total: | 40 pcs | 喷嘴总数: | 40个 |
| LED: | 3 pcs | 池底灯: | 3个 |
| Small led: | 26 pcs | 小灯珠: | 26个 |
| Total power: | 6.75kW | 总功率: | 6.75kW |

MEXDA 32



WS-PC06ST

Size: 5900x2400x1470mm



WATER JETS TEMPERATURE SETTING



LED LIGHT



OZONE

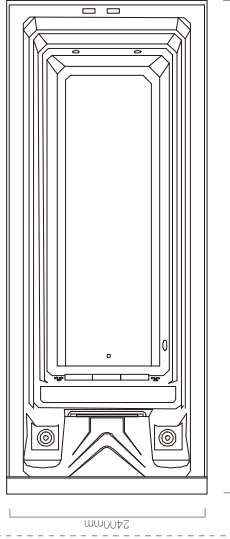

5900mm



Product Detail

| | | | |
|-----------------------|--------|---------|--------|
| Control system: | 1 set | 控制系统: | 1套 |
| Swim training system: | 1 set | 游泳训练系统: | 1套 |
| Filter pump: | 1 pc | 过滤器: | 1台 |
| Jet total: | 6 pcs | 喷嘴总数: | 6个 |
| LED: | 4 pcs | 池底灯: | 4个 |
| Total power: | 6.55kW | 总功率: | 6.55kW |

WS-S06M

Size: 5900x2200x1610mm



WATER JETS



LED LIGHT



OZONE

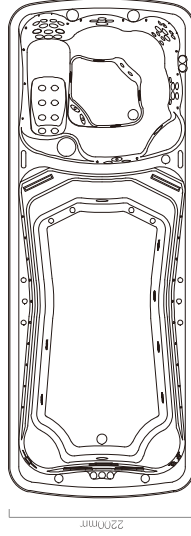

5900mm



Product Detail

Message Pool / 按摩池

| | | | |
|-----------------|--------|-------|--------|
| Control system: | 1 set | 控制系统: | 1套 |
| Water pump: | 2 pcs | 水泵: | 2台 |
| Filter pump: | 1 pc | 过滤器: | 1台 |
| Jet total: | 48 pcs | 喷嘴总数: | 48个 |
| Small jet: | 17 pcs | 小灯: | 17个 |
| LED: | 1 pc | 池底灯: | 1个 |
| Total power: | 6.95kW | 总功率: | 6.95kW |

Swimming Pool / 游泳池

| | | | |
|-----------------|---------|-------|---------|
| Control system: | 1 set | 控制系统: | 1套 |
| Water pump: | 3 pcs | 水泵: | 3台 |
| Filter pump: | 1 pc | 过滤器: | 1台 |
| Jet total: | 19 pcs | 喷嘴总数: | 19个 |
| Water column: | 4 pcs | 喷水柱: | 4个 |
| Small jet: | 20 pcs | 小灯: | 20个 |
| LED: | 2 pcs | 池底灯: | 2个 |
| Total power: | 10.35kW | 总功率: | 10.35kW |





WS-SP500

Size: 5000x2500x1600mm

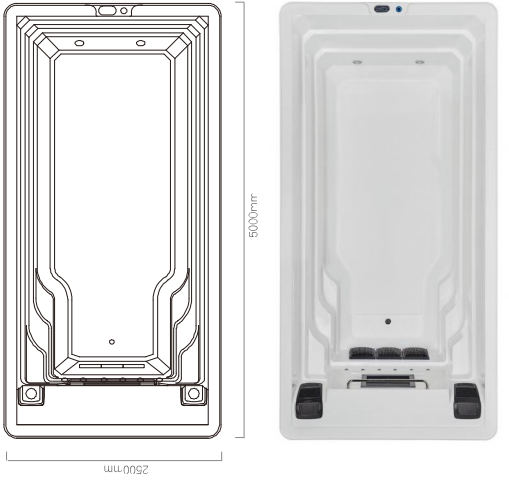

Product Detail

| | | | |
|-----------------------|--------|---------|--------|
| Control system: | 1 set | 控制系统: | 1套 |
| Swim training system: | 1 set | 游泳训练系统: | 1套 |
| Filter pump: | 1 pc | 过滤器: | 1台 |
| Jet total: | 6 pcs | 喷嘴总数: | 6个 |
| LED: | 4 pcs | 池底灯: | 4个 |
| Total power: | 9.35kW | 总功率: | 9.35kW |

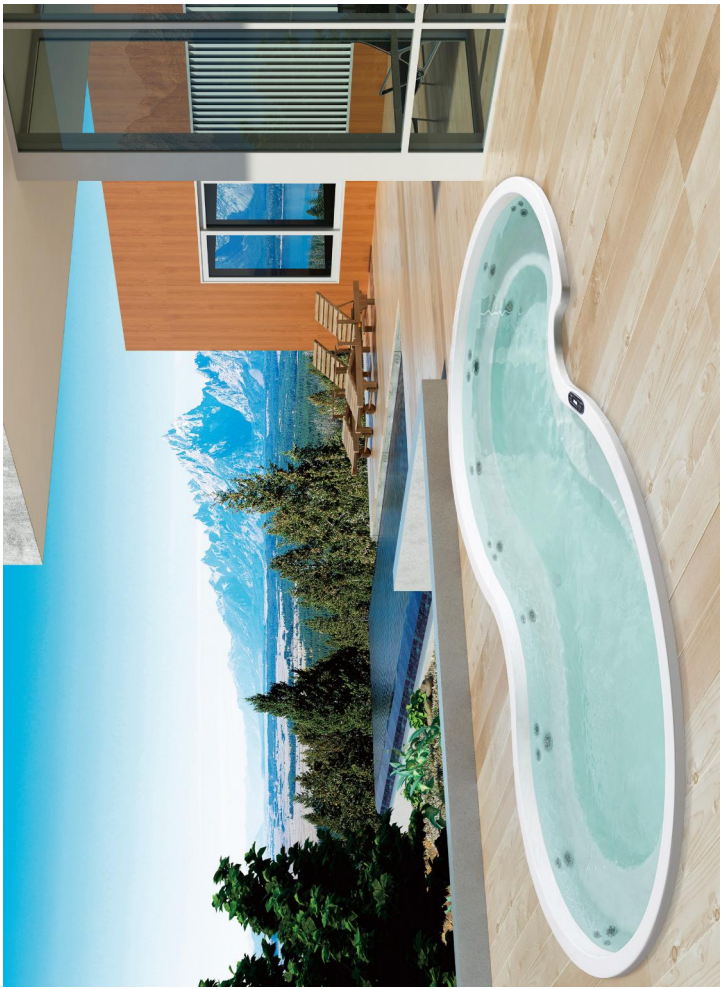

WS-PC06CH

Size: 6000x3000x900mm



Product Detail

| | | | |
|-----------------|--------|-------|--------|
| Control system: | 1 set | 控制系统: | 1套 |
| Water pump: | 2 pcs | 水泵: | 2台 |
| Filter pump: | 1 pc | 过滤器: | 1台 |
| Jet total: | 38 pcs | 喷嘴总数: | 38个 |
| LED: | 1 pc | 池底灯: | 1个 |
| Total power: | 6.75kW | 总功率: | 6.75kW |



WS-SP500-MS

Size: 5000x2500x1600mm



Product Detail

| | | | |
|-----------------------|---------|---------|---------|
| Control system: | 1 set | 控制系统: | 1套 |
| Swim training system: | 1 set | 游泳训练系统: | 1套 |
| Water pump: | 1 pc | 水泵: | 1台 |
| Filter pump: | 1 pc | 过滤器: | 1台 |
| Jet total: | 29 pcs | 喷嘴总数: | 29个 |
| LED: | 4 pcs | 池底灯: | 4个 |
| Total power: | 11.55kW | 总功率: | 11.55kW |

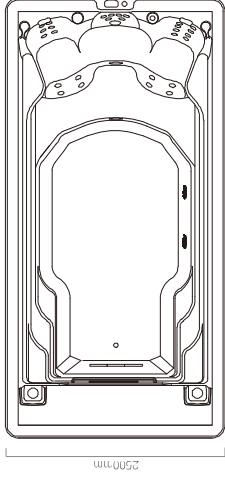

WS-125A III

Size: 5500x2300x1350mm



Product Detail

| | | | |
|-----------------------|--------|---------|--------|
| Control system: | 1 set | 控制系统: | 1套 |
| Swim training system: | 1 set | 游泳训练系统: | 1套 |
| Water pump: | 1 pc | 水泵: | 1台 |
| Filter pump: | 1 pc | 过滤器: | 1台 |
| Jet total: | 20 pcs | 喷嘴总数: | 20个 |
| LED: | 3 pcs | 池底灯: | 3个 |
| Total power: | 8.05kW | 总功率: | 8.05kW |

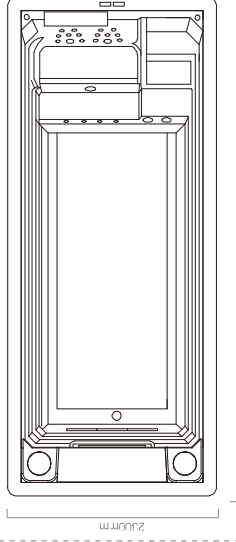



WS-115E III-U

Size: 5280x2200x1250mm



WATER JETS



TEMPERATURE SETTING



LED LIGHT



OZONE

Product Detail

| | | | |
|-----------------|---------|-------|---------|
| Control system: | 1 set | 控制系统: | 1套 |
| Water pump: | 4 pcs | 水泵: | 4台 |
| Filter pump: | 1 pc | 过滤器: | 1台 |
| Jet total: | 27 pcs | 喷嘴总数: | 27个 |
| Leads: | 2 pcs | 池底灯: | 2个 |
| Total power: | 11.85kW | 总功率: | 11.85kW |

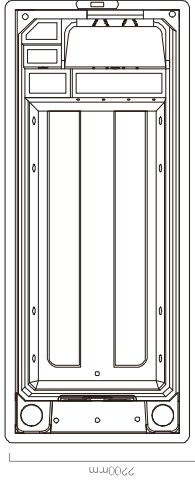

5280mm



WS-125A III-U

Size: 5500x2300x1350mm



WATER JETS



TEMPERATURE SETTING



LED LIGHT



UV LIGHT



OZONE

Product Detail

| | | | |
|-----------------|---------|-------|---------|
| Control system: | 1 set | 控制系统: | 1套 |
| Water pump: | 4 pcs | 水泵: | 4台 |
| Filter pump: | 1 pc | 过滤器: | 1台 |
| Jet total: | 23 pcs | 喷嘴总数: | 23个 |
| Leads: | 1 pc | 池底灯: | 1个 |
| Total power: | 11.85kW | 总功率: | 11.85kW |

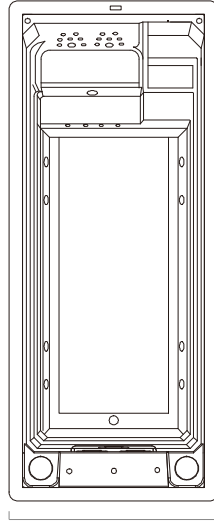

2300mm

5500mm



WS-115F III

Size: 5000x2200x1250mm



WATER JETS



TEMPERATURE SETTING



LED LIGHT



OZONE

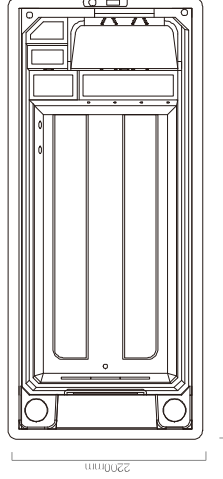

5000mm



Product Detail

| | | | |
|-----------------------|--------|---------|--------|
| Control system: | 1 set | 控制系统: | 1套 |
| Swim training system: | 1 set | 游泳训练系统: | 1套 |
| Water pump: | 1 pc | 水泵: | 1台 |
| Filter pump: | 1 pc | 过滤泵: | 1台 |
| Jet total: | 24 pcs | 喷嘴总数: | 24个 |
| LED: | 4 pcs | 池底灯: | 4个 |
| Total power: | 8.05KW | 总功率: | 8.05KW |



WS-PC05CH

Size: 5000x3000x900mm



WATER JETS



LED LIGHT



OZONE

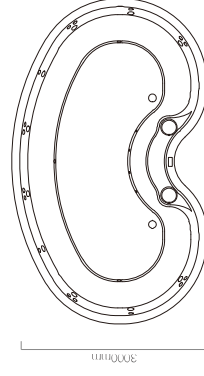

5000mm



Product Detail

| | | | |
|-----------------|--------|-------|--------|
| Control system: | 1 set | 控制系统: | 1套 |
| Water pump: | 1 pc | 水泵: | 1台 |
| Filter pump: | 1 pc | 过滤泵: | 1台 |
| Jet total: | 30 pcs | 喷嘴总数: | 30个 |
| LED: | 1 pc | 池底灯: | 1个 |
| Total power: | 5.95KW | 总功率: | 5.95KW |



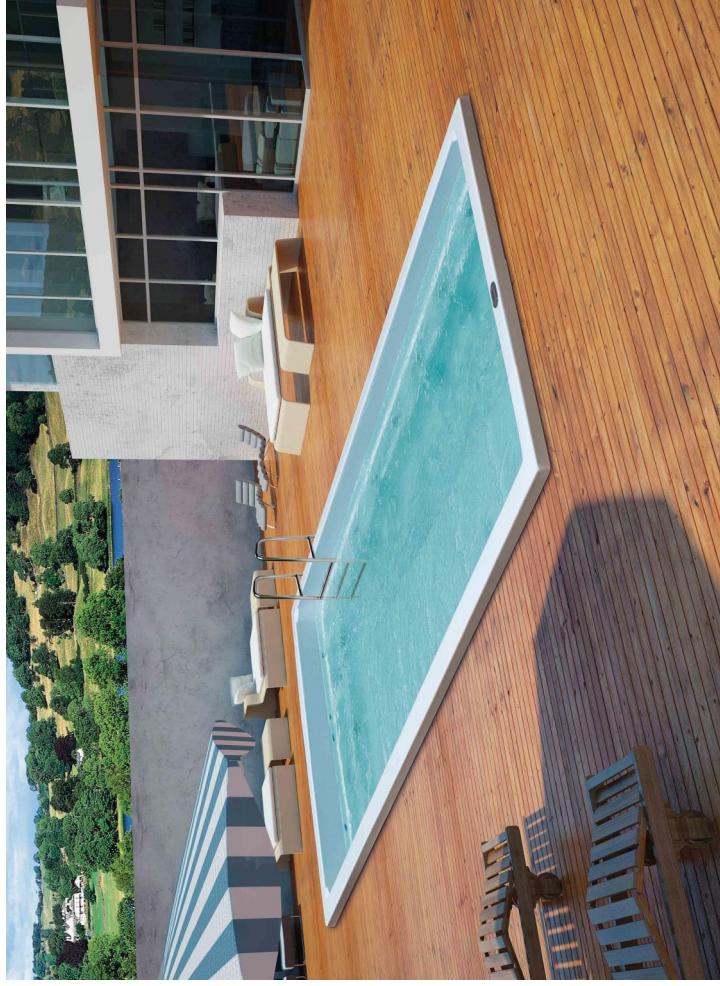

WS-PC05ST

Size: 5000x2400x1470mm



WATER JETS TEMPERATURE SETTING

LED LIGHT

OZONE

Product Detail

| | | | |
|-----------------------|--------|---------|--------|
| Control system: | 1 set | 控制系统: | 1套 |
| Swim training system: | 1 set | 游泳训练系统: | 1套 |
| Filter pump: | 1 pc | 过滤器: | 1台 |
| Jet total: | 6 pcs | 喷嘴总数: | 6个 |
| Leg: | 4 pcs | 池底灯: | 4个 |
| Total power: | 6.55kW | 总功率: | 6.55kW |

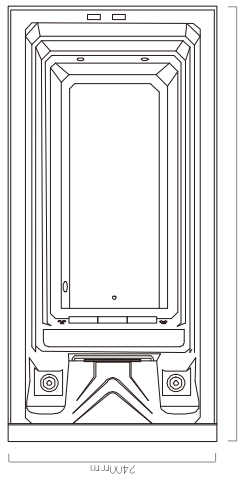

WS-PC05

Size: 5000x3000x1100mm



WATER JETS TEMPERATURE SETTING

LED LIGHT

OZONE

Product Detail

| | | | |
|-----------------|--------|-------|--------|
| Control system: | 1 set | 控制系统: | 1套 |
| Water pump: | 1 pc | 水泵: | 1台 |
| Filter pump: | 1 pc | 过滤器: | 1台 |
| Jet total: | 18 pcs | 喷嘴总数: | 18个 |
| water column: | 4 pcs | 喷水柱: | 4个 |
| Leg: | 2 pcs | 池底灯: | 2个 |
| Total power: | 5.25kW | 总功率: | 5.25kW |

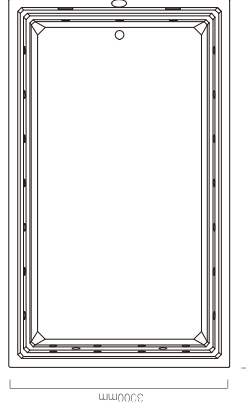

WS-PC05ST-S

Size: 5000x2400x1470mm



Product Detail

| | | | |
|-----------------------|--------|---------|--------|
| Control system: | 1 set | 控制系统: | 1套 |
| Swim training system: | 1 set | 游泳训练系统: | 1套 |
| Filter pump: | 1 pc | 过滤器: | 1台 |
| Jet total: | 6 pcs | 喷嘴总数: | 6个 |
| Leg: | 4 pcs | 池底灯: | 4个 |
| Total power: | 6.55kW | 总功率: | 6.55kW |

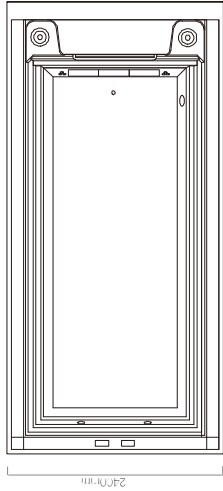

5000mm



WS-115A III

Size: 3880x2200x1250mm



Product Detail

| | | | |
|-----------------------|--------|---------|--------|
| Control system: | 1 set | 控制系统: | 1套 |
| Swim training system: | 1 set | 游泳训练系统: | 1套 |
| Water pump: | 1 pc | 水泵: | 1台 |
| Filter pump: | 1 pc | 过滤器: | 1台 |
| Jet total: | 24 pcs | 喷嘴总数: | 24个 |
| Leg: | 4 pcs | 池底灯: | 4个 |
| Total power: | 8.05kW | 总功率: | 8.05kW |

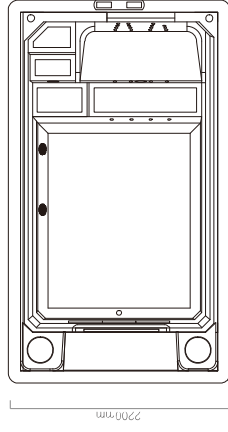

3880mm



WS-115A III-U

Size: 3880x2200x1250mm



WATER JETS TEMPERATURE SETTING LED LIGHT OZONE

Product Detail

| | | | |
|-----------------|---------|-------|---------|
| Control system: | 1 set | 控制系统: | 1套 |
| Water pump: | 4 pcs | 水泵: | 4台 |
| Filter pump: | 1 pc | 过滤器: | 1台 |
| Jet total: | 27 pcs | 喷嘴总数: | 27个 |
| LED: | 2 pcs | 池底灯: | 2个 |
| Total power: | 11.85kW | 总功率: | 11.85kW |

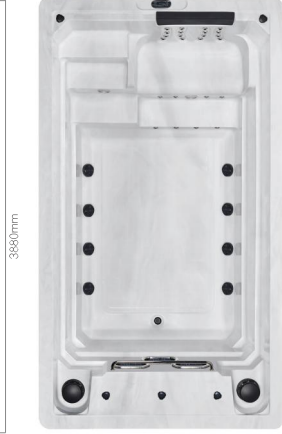
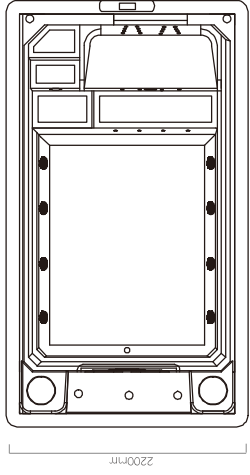

MEXDA 47



WS-S04

Size: 4090x2200x1110mm



WATER JETS TEMPERATURE SETTING LED LIGHT OZONE

Product Detail

| | | | |
|-----------------|--------|-------|--------|
| Control system: | 1 set | 控制系统: | 1套 |
| Water pump: | 3 pcs | 水泵: | 3台 |
| Filter pump: | 1 pc | 过滤器: | 1台 |
| Jet total: | 26 pcs | 喷嘴总数: | 26个 |
| Water column: | 4 pcs | 喷冰柱: | 4个 |
| LED: | 3 pcs | 池底灯: | 3个 |
| Small led: | 18 pcs | 小灯珠: | 18个 |
| Total power: | 8.25kW | 总功率: | 8.25kW |

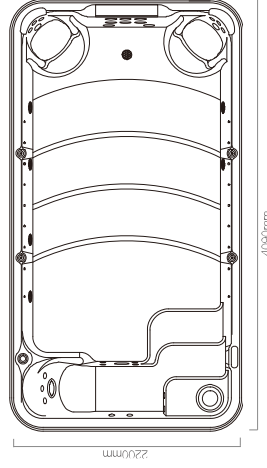

MEXDA 48

WS-S04X

Size: 3990x2260x950mm



POP-UP WATERFALL WITH LIGHT



WATER JETS



WATERFALL



TEMPERATURE SETTING



LED LIGHT



OZONE

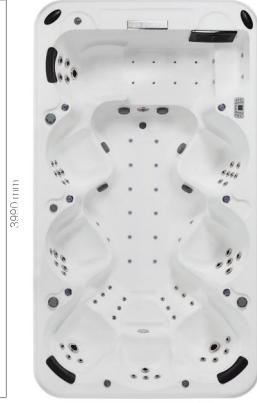
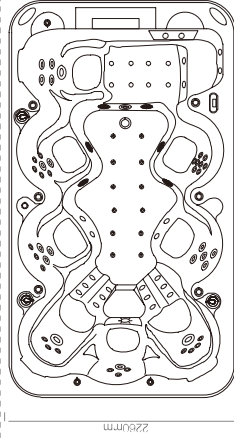

Product Detail

| | | | |
|------------------------------|--------|---------|--------|
| Control system: | 1 set | 控制系统: | 1套 |
| Water pump: | 3 pcs | 水泵: | 3台 |
| Filter pump: | 1 pc | 过滤器: | 1台 |
| Jet total: | 85 pcs | 喷嘴总数: | 85个 |
| Pop-up waterfall with light: | 6 pcs | 带灯升降喷泉: | 6个 |
| LED: | 1 pc | 池底灯: | 1个 |
| Total power: | 8.95kW | 总功率: | 8.95kW |



MEXDA 49



WS-S04B

Size: 3900x2200x1450mm



WATER JETS



LED LIGHT



OZONE

Product Detail

| | | | |
|-----------------|---------|-------|---------|
| Control system: | 1 set | 控制系统: | 1套 |
| Water pump: | 3 pcs | 水泵: | 3台 |
| Filter pump: | 1 pc | 过滤器: | 1台 |
| Jet total: | 31 pcs | 喷嘴总数: | 31个 |
| water column: | 6 pcs | 喷水柱: | 6个 |
| LED: | 2 pcs | 池底灯: | 2个 |
| Small led: | 28 pcs | 小灯珠: | 28个 |
| Total power: | 10.35kW | 总功率: | 10.35kW |

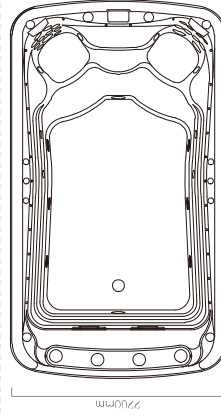

MEXDA 50



WS-S38

Size: 3760x2080x1110mm



WATER JETS WATERFALL TEMPERATURE SETTING LED LIGHT OZONE

Product Detail

| | | | |
|-----------------|---------|-------|---------|
| Control system: | 1 set | 控制系统: | 1套 |
| Water pump: | 3 pcs | 水泵: | 3台 |
| Filter pump: | 1 pc | 过滤器: | 1台 |
| Jet total: | 51 pcs | 喷嘴总数: | 51个 |
| water column: | 6 pcs | 喷水柱: | 6个 |
| LED: | 4 pcs | 池底灯: | 4个 |
| Small led: | 12 pcs | 小灯珠: | 12个 |
| Total power: | 14,05KW | 总功率: | 14,05KW |

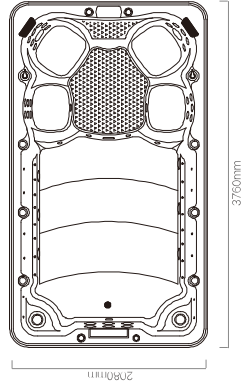

WS-PC04CH

Size: 4500x3000x900mm



WATER JETS LED LIGHT UV LIGHT OZONE

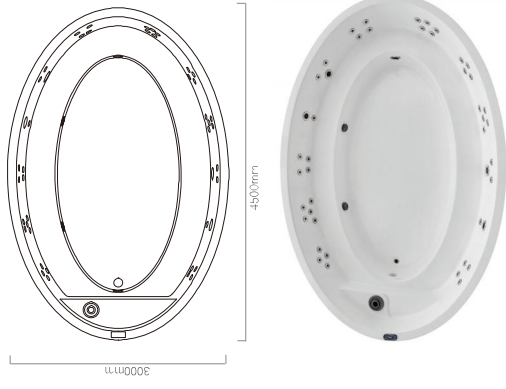

Product Detail

| | | | |
|-----------------|--------|-------|--------|
| Control system: | 1 set | 控制系统: | 1套 |
| Water pump: | 1 pc | 水泵: | 1台 |
| Filter pump: | 1 pc | 过滤器: | 1台 |
| Jet total: | 46 pcs | 喷嘴总数: | 46个 |
| LED: | 1 pc | 池底灯: | 1个 |
| Total power: | 5,95KW | 总功率: | 5,95KW |



WS-P001

Size: 3500x950mm



Product Detail

| | | | |
|-----------------|--------|-------|--------|
| Control system: | 1 set | 控制系统: | 1套 |
| Water pump: | 2 pcs | 水泵: | 2台 |
| Filter pump: | 1 pc | 过滤泵: | 1台 |
| Jet total: | 81 pcs | 喷嘴总数: | 81个 |
| LED: | 2 pcs | 池底灯: | 2个 |
| Total power: | 8.85KW | 总功率: | 8.85KW |

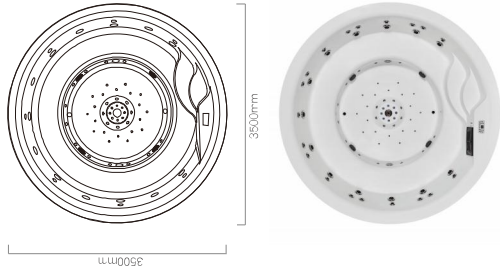

WS-PC01A

Size: 3000x930mm



Product Detail

| | | | |
|-----------------|--------|-------|--------|
| Control system: | 1 set | 控制系统: | 1套 |
| Water pump: | 2 pcs | 水泵: | 2台 |
| Filter pump: | 1 pc | 过滤泵: | 1台 |
| Jet total: | 28 pcs | 喷嘴总数: | 28个 |
| LED: | 1 pc | 池底灯: | 1个 |
| Small led: | 9 pcs | 小灯珠: | 9个 |
| Total power: | 3.75KW | 总功率: | 3.75KW |

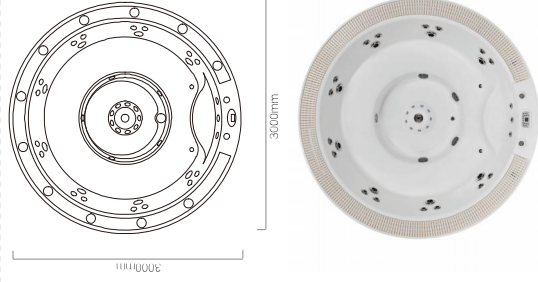



WS-PC01

Size: 3000x1050mm



Product Detail

| | | | |
|-----------------|--------|-------|--------|
| Control system: | 1 set | 控制系统: | 1套 |
| Water pump: | 2 pcs | 水泵: | 2台 |
| Filter pump: | 1 pc | 过滤器: | 1台 |
| Jet total: | 53 pcs | 喷嘴总数: | 53个 |
| LED: | 1 pc | 池底灯: | 1个 |
| Total power: | 7.15kW | 总功率: | 7.15kW |

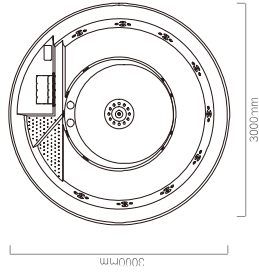

WS-PC02

Size: 3000x3000x1050mm



Product Detail

| | | | |
|-----------------|--------|-------|--------|
| Control system: | 1 set | 控制系统: | 1套 |
| Water pump: | 2 pcs | 水泵: | 2台 |
| Filter pump: | 1 pc | 过滤器: | 1台 |
| Jet total: | 60 pcs | 喷嘴总数: | 60个 |
| LED: | 1 pc | 池底灯: | 1个 |
| Total power: | 7.85kW | 总功率: | 7.85kW |

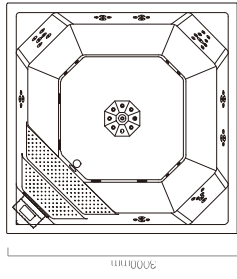

WS-PC03

Size: 3000x3000x1000mm



WATER JETS



LED LIGHT



UV LIGHT



OZONE

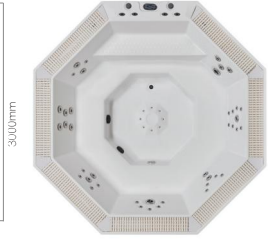
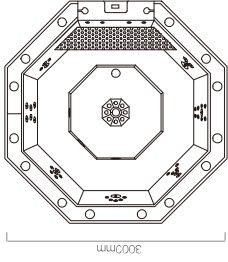

Product Detail

| | | | |
|-----------------|--------|-------|--------|
| Control system: | 1 set | 控制系统: | 1套 |
| Water pump: | 1 pc | 水泵: | 1台 |
| Filter pump: | 1 pc | 过滤器: | 1台 |
| Jet total: | 50 pcs | 喷嘴总数: | 50个 |
| water column: | 4 pcs | 晒水柱: | 4个 |
| LED: | 1 pc | 池底灯: | 1个 |
| Total power: | 6.5KW | 总功率: | 6.25KW |

Swim Spa Accessories



BALBOA control system
美国进口 Balboa 控制系统



Control system
国产控制系统



Ultraviolet sterilization
紫外线杀菌灯



Water pump
水泵



USA heat pump
美国进口空气能热泵



Heat pump
国产空气能热泵



Sand filler
沙缸



PU isolation
PU 保温层



3-Steps stair
三级梯



Color option for america aristech acrylic

Premium Aristech Acrylics...Setting Quality Standard.
It's the Unique Benefit of Aristech Cast Acrylics.
The Unique Benefit of Aristech Cast Acrylics
High-Gloss Finish...Aristech Acrylic Sheet products retain their glossy appearance through years of normal wear and tear.
Easy To Clean...Hard non-porous surface is less susceptible to mildew and algae.
Color Fast...Won't fade or dull...even in sunlight.
Chemical & Stain Resistant...Resists common household stains such as lipstick, hair dye, ink and crayon.
High Heat Retention...Warm to the touch, providing a more comfortable bathing experience.
Vast Color & Design Choices...Aristech Cast Acrylics provide manufacturers unlimited design freedom.
Easy To Repair...Because the color goes all the way through.
Login or register to post comments



Cloudy blue 云彩蓝



cloudy black 云彩黑



cloudy green 云彩绿

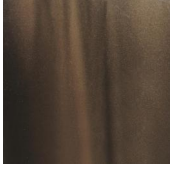

mayan copper 古铜色

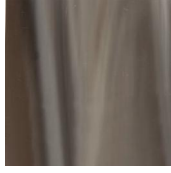

sunset 日落



gypsum white 石膏白



cloudy grey 云彩灰

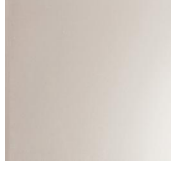

pearl white 珍珠白



pearl grey 珍珠灰



white 纯白

Color option for PS skirt

2019 Style ▼



Grey color PS skirt 灰色



Coffee color PS skirt 咖啡色

2015 Style ▼



Grey color PS skirt 灰色



Coffee color PS skirt 咖啡色



Teak color PS skirt 柚木色



Red-brown PS skirt 棕红色

