



Foshan Gaoming Muhe Jingcheng Sanitary Ware Co., Ltd.

📍 Add : Room1-4, FirstFloor, Workshop 1, No.568 Yangxi Road, Yanghe Town, Gaoming, Foshan, Guangdong, 528513, China

☎ Tel :+86-13702859838

✉ Email : info@oceanfuture.cn

🌐 Website: www.oceanfuturespas.com

Sauna room series





sauna solutions designed to meet your
wellness and relaxation needs

About Ocean Future

With over 20 years of craftsmanship, we have reimagined the sauna experience and set a new benchmark for healthy living.

Since the establishment of Ocean Future, we have always adhered to the persistent pursuit of high - end quality, focusing on the high - end sauna room field. In the process of research, development and manufacturing, we take technological innovation as the driving force, skillfully integrate cutting - edge technology with traditional craftsmanship, and are committed to carefully carving a "breathable healing space" for global users.

Over the past 20 - plus years, we have attentively perceived the temperature of every inch of wood, presenting the gifts of nature in the warmest and most comfortable manner. We precisely control the flow of every degree of heat energy to ensure its most reasonable and efficient distribution within the space. Every detail carries our solemn commitment to quality life. With our practical actions, we set a new benchmark for healthy lifestyle and lead the industry towards a higher - quality future.

-  High-end Brand
-  Cutting-edge Strength
-  Customization Options
-  Professional Process
-  Exceptional Service



We have been specializing in the field of healthy saunas for more than **20 years**

Ocean Future offers a variety of high-quality sauna rooms

[A powerful factory at the source]

[There are no middlemen]

[The brand is guaranteed]



has been operating
20⁺
years



production base
50000
m²



company employees
200⁺



Create things with ingenuity

Go through multiple processes
just for the pursuit of perfection

PRODUCTION PROCESS



Step 1: Carefully select log materials

With a mellow woody fragrance, environmentally friendly and reassuring.



Step 2: Cutting/Processing the materials

Using precise measurements as the standard and focusing on details as the foundation.



Step 3: Mortise and tenon jointing

The structure is stable and it remains as good as new over time.

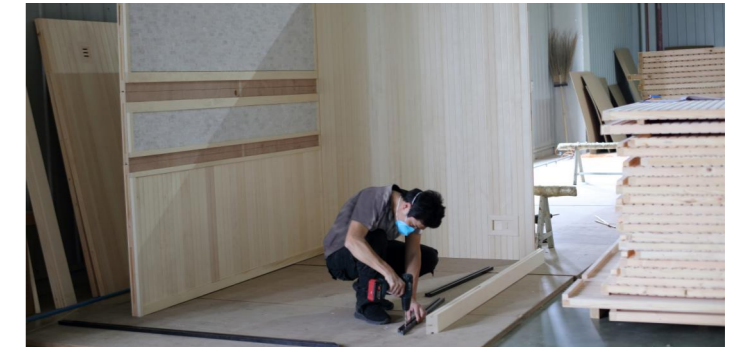

Step 4: Manual assembly

Locking in the warmth and condensing the energy.



Step 5: Conducting a safety electrical test

Taking safety as the core to ensure a worry-free experience.



Step 6: Shockproof packaging

Providing protection throughout the whole process, ensuring it arrives home safely.

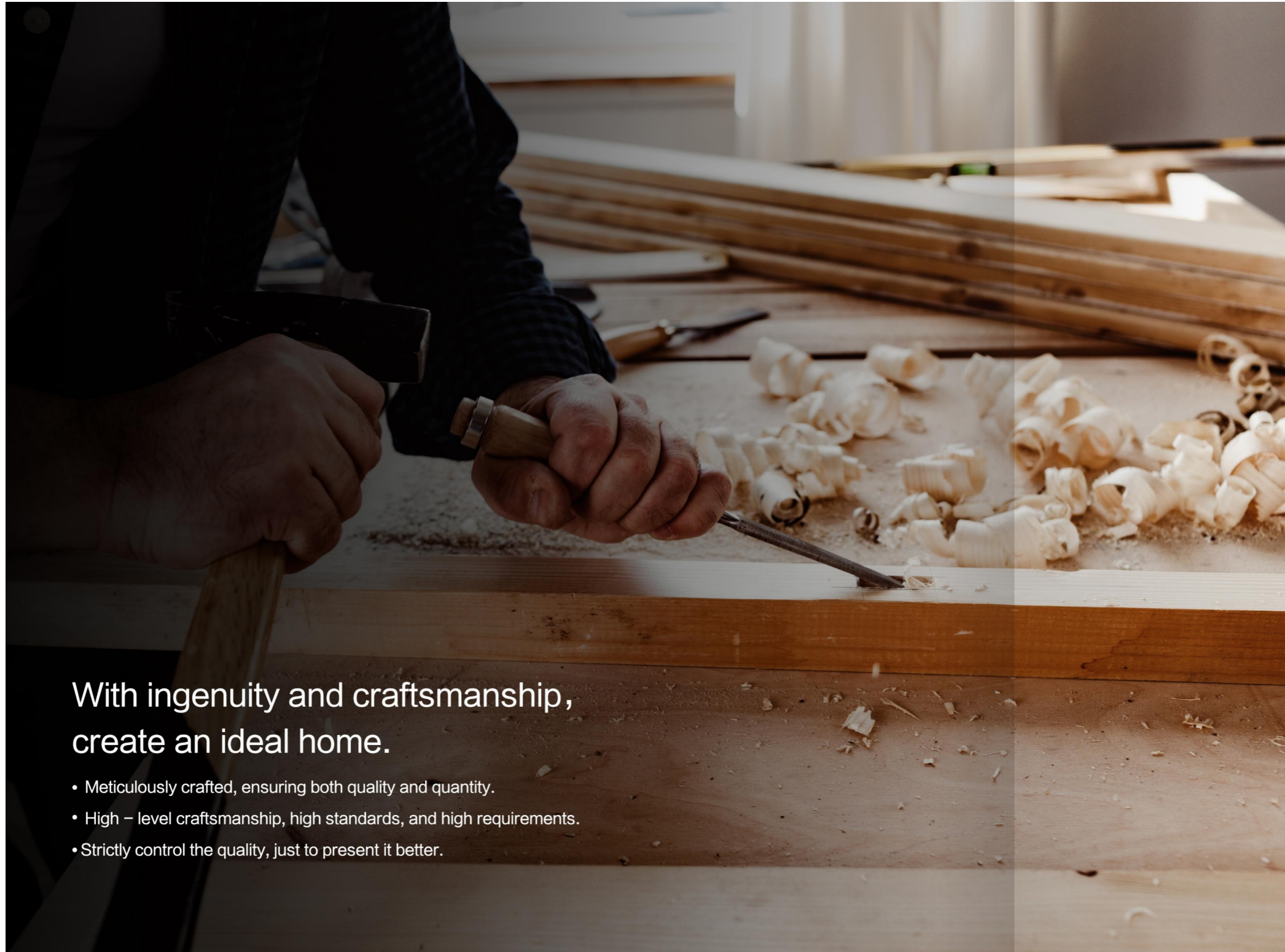

With ingenuity and craftsmanship,
create an ideal home.

- Meticulously crafted, ensuring both quality and quantity.
- High – level craftsmanship, high standards, and high requirements.
- Strictly control the quality, just to present it better.



The Enchanting Journey of High - Quality Wood



**Sauna
Room**

Origin Traceability

The wood selected for our sauna rooms is sourced from regions such as Canada, the United States, Sweden, and Russia. The wood nurtured in the vast forests of Canada features uniform texture and tough quality; the wood from the United States, with its superior growth environment, has excellent stability; the high forest coverage in Sweden results in wood with moderate density and top - notch quality; and the Russian wood, with a long growth cycle, is hard and has unique durability. These woods from different origins all carry the natural imprints of their local areas, infusing the sauna rooms with a natural atmosphere.

Material Advantages

The high - quality wood chosen for our sauna rooms has numerous outstanding advantages. It emits a natural aroma that can soothe the body and mind during the sauna process, bringing a pleasant olfactory experience. Meanwhile, the wood has good durability and can withstand long - term high - temperature and humid environments without being prone to deformation or cracking. Moreover, its excellent heat - insulation performance can effectively maintain the temperature inside the sauna room, allowing you to enjoy a more stable and comfortable sauna time.

User Experience

The high - quality wood brings a full - range experience upgrade for users. Stepping into the sauna room, the natural wood textures come into view, creating a warm and comfortable sense of space, and instantly relaxing your body and mind. During use, the warm texture of the wood when it comes into contact with the skin, as well as the continuously emitted natural aroma, can immerse you in a pleasant sauna atmosphere. Whether it's a short - term relaxation or long - term health preservation, the high - quality wood in our sauna rooms can bring you a lasting and enjoyable experience.

Quality Enhancement

The use of high - quality wood has greatly enhanced the overall quality of the sauna rooms. The natural wood texture endows the sauna rooms with a natural and rustic beauty, creating a warm and cozy space atmosphere. Its durability ensures the long - term use of the sauna rooms and reduces maintenance costs. The comfort is self - evident. The warm and smooth texture when in contact with the skin allows you to fully relax during the sauna process and enjoy a long - lasting and pure sauna experience.

Unlock the Luxury - Enjoyment Code of the Top - Tier Sauna Room



HIGH-QUALITY SOLID WOOD

It complies with the standards
so you can use it with confidence

Explore Our Premium Sauna Room Collection

Ocean Future offers a variety of high-quality sauna rooms that are carefully designed to provide a comfortable and relaxing experience while also providing health benefits. Our saunas use advanced heating technology to quickly reach the ideal temperature so that you can enjoy the sauna experience as soon as possible.

Equipped with an advanced temperature control system, our sauna rooms can accurately adjust to the ideal temperature you need, bringing a long-lasting and stable sauna experience. At the same time, energy-saving technology is used to improve energy efficiency while reducing energy consumption, which is in line with the concept of environmental protection.

Our sauna rooms are carefully crafted with high-quality wood and high-temperature resistant materials. High-quality wood not only provides a natural aroma, but also increases the durability and comfort of the sauna, bringing long-lasting enjoyment. Each sauna room is strictly processed to ensure that it remains stable and safe in high-temperature environments.

We offer a variety of sizes and design styles to choose from to suit different family needs and space layouts. Our sauna rooms provide you with a private and comfortable space, allowing you to enjoy a SPA-like health experience at home. Whether it is to release stress, promote blood circulation, or improve immunity, you can easily achieve it.





Infrared Sauna Room for Health and Relaxation

Our infrared sauna rooms use advanced far-infrared heating technology to effectively penetrate the skin layer and quickly raise the body temperature, thereby promoting blood circulation and metabolism, helping to relieve muscle fatigue, eliminate toxins from the body, and bring a deep relaxation effect.

Moreover, our infrared saunas are energy efficient and can quickly reach the ideal temperature in a short period of time, reducing waiting time and energy waste. Even if it is used for a long time, it can still maintain low energy consumption, which is both economical and efficient.

The construction of the sauna room is made of high-quality natural wood, which is environmentally friendly and non-toxic. It is not only durable but also can create a warm and natural sauna environment. Using natural wood not only enhances the comfort of the sauna room, but also brings a more natural atmosphere to the user and enhances the overall relaxation effect.

In order to improve the convenience and entertainment of use, Ocean Future's infrared sauna rooms are equipped with a simple and intuitive control panel that allows you to easily adjust the temperature and set the time according to your needs. In addition, our sauna rooms offer modern amenities including FM, Bluetooth, and USB connectivity to further enhance the overall enjoyment experience.

Infrared Sauna Room

Modern wellness devices offer potential health benefits in a soothing and efficient manner

Infrared Sauna: A Health Journey from the Inside Out

In the fast-paced modern life, people are paying more and more attention to their physical and mental health. Infrared sauna, as a new way of health preservation, is attracting the attention of more and more people with its unique charm. It not only provides a comfortable experience but also penetrates deep into the body, bringing a series of surprising health benefits.



Seven Health Benefits of Infrared Sauna:

- **Promote blood circulation and improve cardiovascular health:**
The warming effect of infrared rays can dilate blood vessels, accelerate blood circulation, help lower blood pressure, improve heart function, and prevent cardiovascular diseases.
- **Sweat deeply and expel toxins:**
Infrared rays can penetrate deep into the subcutaneous tissue, activate the sweat glands, promote sweating in the human body, and help expel toxins such as heavy metals, lactic acid, and uric acid accumulated in the body, purifying the body.
- **Relieve pain and relax muscles:**
The warming effect of infrared rays can effectively relieve symptoms such as muscle soreness, joint pain, and arthritis, helping to relax the body and mind and relieve stress.
- **Burn calories and assist in weight loss:**
During an infrared sauna session, the human body consumes a large amount of energy, which is equivalent to a moderate-intensity exercise, helping to burn fat and control weight.
- **Improve skin condition and delay aging:**
Infrared rays can promote skin metabolism, increase the production of collagen, improve skin elasticity, fade wrinkles, and make the skin smoother and more delicate.
- **Enhance immunity and prevent diseases:**
Infrared rays can activate human immune cells, enhance immunity, help resist the invasion of viruses and bacteria, and prevent diseases such as colds.
- **Improve sleep quality and relieve fatigue:**
An infrared sauna can help relax the body and mind, relieve stress, improve sleep quality, and make people refreshed the next day.



Choose a high-quality infrared sauna room and start your health journey!

Our infrared sauna rooms are made of high-quality materials, are safe and environmentally friendly, and are equipped with an advanced far-infrared heating system, providing you with a comfortable and healthy sauna experience. Take action now and enjoy the health and beauty brought by the infrared sauna!







Infrared Sauna Room OFS01-1



Specification

Size	W900*D1050*H1900mm
Wood	Hemlock/Red Cedar/Poplar
Control System	1set (FM, Bluetooth, USB)
Heating System	Far Infrared Heating Plate
Speaker	2pcs
Square Colorful Lamp	1pc
Colorful Light Belt	On Back Rest
Wood Handle	1pc
Surface	Painted
Tempered Glass	Dark Brown
Total Power	1666W
Capacity	1 People

Product Characteristics

-  High Quality Wood
-  Brilliant Lighting
-  Infrared Heating
-  Intelligent Control
-  High Efficiency Heating
-  Perfect Accessories

Dimensions

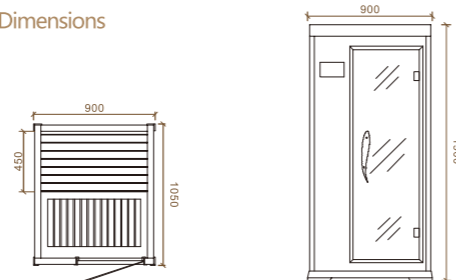

Features



Control System

Equipped with a smart control panel, you can effortlessly set your preferred settings for a personalized sauna session every time.



Infrared Heating

The sauna utilizes advanced infrared heating technology, which deeply penetrates the skin for a more effective and soothing experience.



Sauna Speaker

The built-in sauna sound system can play your favorite music or relaxation audio to further enhance the relaxation effect of the sauna.

Wood Colors



Hemlock

Red Cedar

Poplar



Infrared Sauna Room OFS01-2



Specification

Size	W1200*D1000*H1900mm
Wood	Hemlock/Red Cedar/Poplar
Control System	1set (FM, Bluetooth, USB)
Heating System	Far Infrared Heating Plate
Speaker	2pcs
Square Colorful Lamp	1pc
Colorful Light Belt	On Back Rest
Wood Handle	1pc
Surface	Painted
Tempered Glass	Dark Brown
Total Power	1812W
Capacity	2 People

Product Characteristics

- High Quality Wood
- Brilliant Lighting
- Infrared Heating
- Intelligent Control
- High Efficiency Heating
- Perfect Accessories

Dimensions

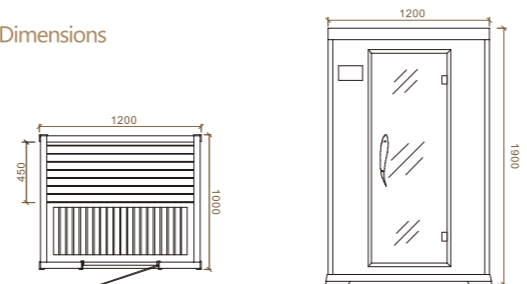

Features



Control System

Equipped with a smart control panel, you can effortlessly set your preferred settings for a personalized sauna session every time.



Infrared Heating

The sauna utilizes advanced infrared heating technology, which deeply penetrates the skin for a more effective and soothing experience.



Sauna Speaker

The built-in sauna sound system can play your favorite music or relaxation audio to further enhance the relaxation effect of the sauna.

Wood Colors



Hemlock

Red Cedar

Poplar

Infrared Sauna Room OFS01-3



Specification

Size	W1500*D1200*H1900mm
Wood	Hemlock/Red Cedar/Poplar
Control System	1set (FM, Bluetooth, USB)
Heating System	Far Infrared Heating Plate
Speaker	2pcs
Square Colorful Lamp	1pc
Colorful Light Belt	On Back Rest
Wood Handle	1pc
Surface	Painted
Tempered Glass	Dark Brown
Total Power	1952W
Capacity	3 People

Product Characteristics

- High Quality Wood
- Brilliant Lighting
- Infrared Heating
- Intelligent Control
- High Efficiency Heating
- Perfect Accessories

Dimensions

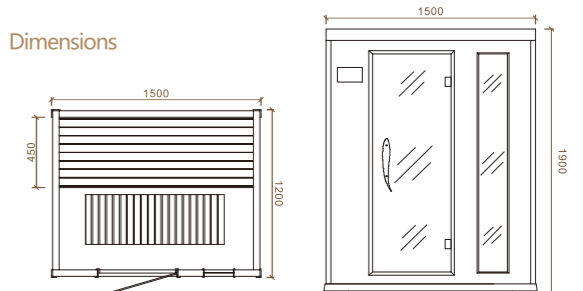

Features



Control System

Equipped with a smart control panel, you can effortlessly set your preferred settings for a personalized sauna session every time.



Infrared Heating

The sauna utilizes advanced infrared heating technology, which deeply penetrates the skin for a more effective and soothing experience.



Sauna Speaker

The built-in sauna sound system can play your favorite music or relaxation audio to further enhance the relaxation effect of the sauna.

Wood Colors



Hemlock

Red Cedar

Poplar







Infrared Sauna Room OFS01-4



Specification

Size	W1500*D1500*H1900mm
Wood	Hemlock/Red Cedar/Poplar
Control System	1set (FM, Bluetooth, USB)
Heating System	Far Infrared Heating Plate
Speaker	2pcs
Square Colorful Lamp	1pc
Colorful Light Belt	On Back Rest
Wood Handle	1pc
Surface	Painted
Tempered Glass	Dark Brown
Total Power	2520W
Capacity	4 People

Product Characteristics

-  High Quality Wood
-  Brilliant Lighting
-  Infrared Heating
-  Intelligent Control
-  High Efficiency Heating
-  Perfect Accessories

Dimensions

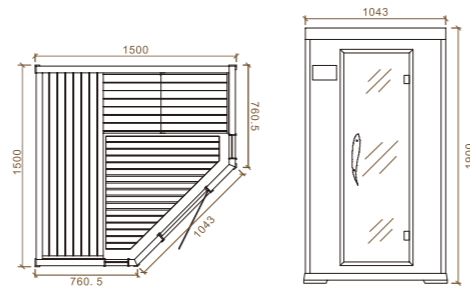

Features



Control System
Equipped with a smart control panel, you can effortlessly set your preferred settings for a personalized sauna session every time.



Infrared Heating
The sauna utilizes advanced infrared heating technology, which deeply penetrates the skin for a more effective and soothing experience.



Sauna Speaker
The built-in sauna sound system can play your favorite music or relaxation audio to further enhance the relaxation effect of the sauna.

Wood Colors



Hemlock

Red Cedar

Poplar



Promote blood circulation and relieve chronic pain

The heat energy dilates blood vessels, improves the efficiency of oxygen delivery in the blood, and alleviates pain problems such as shoulder and neck stiffness and arthritis.



SAUNA ROOM

Joy is nature humanity.
when you sit in the sauna room,
joy will come inside your heart endless

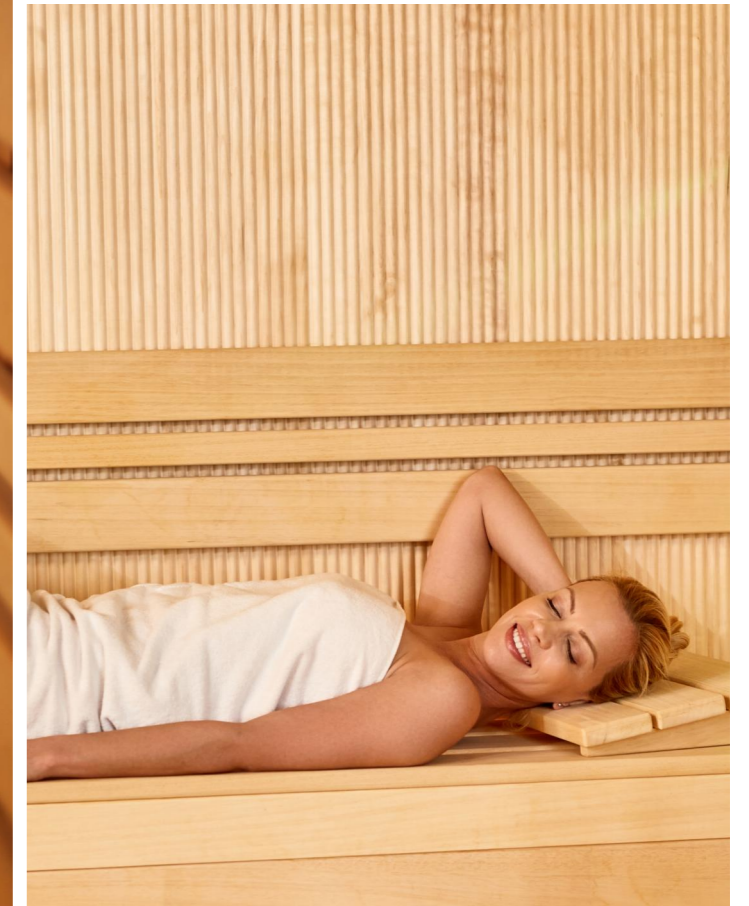

Infrared Sauna Room OFS02-1

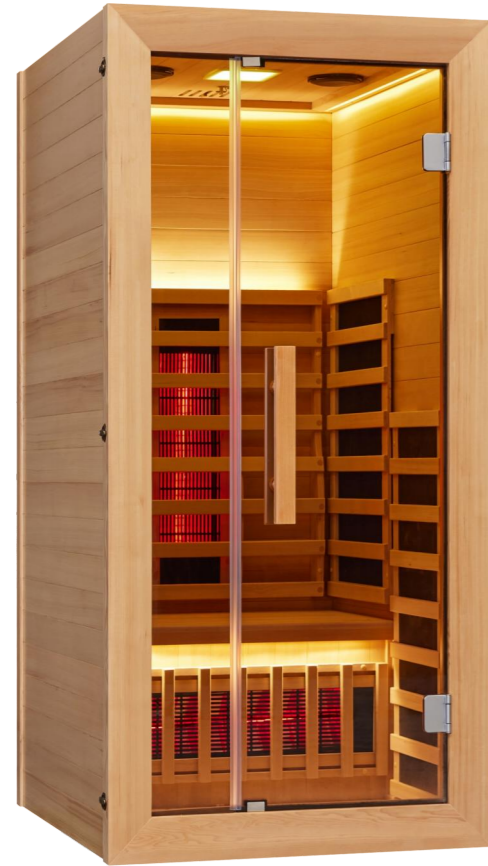

Specification

Size	W900*D1050*H1900mm
Wood	Hemlock/Red Cedar/Poplar
Control System	1set (FM, Bluetooth, USB)
Heating System	Far Infrared Heating Plate
Speaker	2pcs
Square Colorful Lamp	1pc
Colorful Light Belt	On Ceiling
Wood Handle	1pc
Surface	Painted
Tempered Glass	Dark Brown
Total Power	1666W
Capacity	1 People

Product Characteristics

- High Quality Wood
- Brilliant Lighting
- Infrared Heating
- Intelligent Control
- High Efficiency Heating
- Perfect Accessories

Dimensions

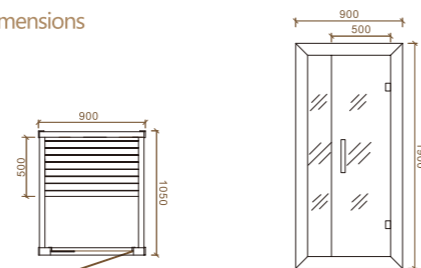

Features



Control System

Equipped with a smart control panel, you can effortlessly set your preferred settings for a personalized sauna session every time.



Infrared Heating

The sauna utilizes advanced infrared heating technology, which deeply penetrates the skin for a more effective and soothing experience.



Sauna Speaker

The built-in sauna sound system can play your favorite music or relaxation audio to further enhance the relaxation effect of the sauna.

Wood Colors



Hemlock

Red Cedar

Poplar

Infrared Sauna Room OFS02-2



Specification

Size	W1200*D1000*H1900mm
Wood	Hemlock/Red Cedar/Poplar
Control System	1set (FM, Bluetooth, USB)
Heating System	Far Infrared Heating Plate
Speaker	2pcs
Square Colorful Lamp	1pc
Colorful Light Belt	On Ceiling
Wood Handle	1pc
Surface	Painted
Tempered Glass	Dark Brown
Total Power	1966W
Capacity	2 People

Product Characteristics

- High Quality Wood
- Brilliant Lighting
- Infrared Heating
- Intelligent Control
- High Efficiency Heating
- Perfect Accessories

Dimensions

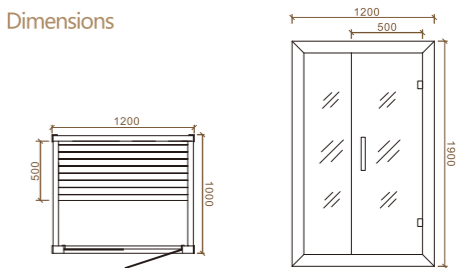

Features



Control System

Equipped with a smart control panel, you can effortlessly set your preferred settings for a personalized sauna session every time.



Infrared Heating

The sauna utilizes advanced infrared heating technology, which deeply penetrates the skin for a more effective and soothing experience.



Sauna Speaker

The built-in sauna sound system can play your favorite music or relaxation audio to further enhance the relaxation effect of the sauna.

Wood Colors



Hemlock

Red Cedar

Poplar

Infrared Sauna Room OFS02-3



Specification

Size	W1500*D1200*H1900mm
Wood	Hemlock/Red Cedar/Poplar
Control System	1set (FM, Bluetooth, USB)
Heating System	Far Infrared Heating Plate
Speaker	2pcs
Square Colorful Lamp	1pc
Colorful Light Belt	On Ceiling
Wood Handle	1pc
Surface	Dark Brown
Tempered Glass	Painted
Total Power	2166W
Capacity	3 People

Product Characteristics

- High Quality Wood
- Brilliant Lighting
- Infrared Heating
- Intelligent Control
- High Efficiency Heating
- Perfect Accessories

Dimensions

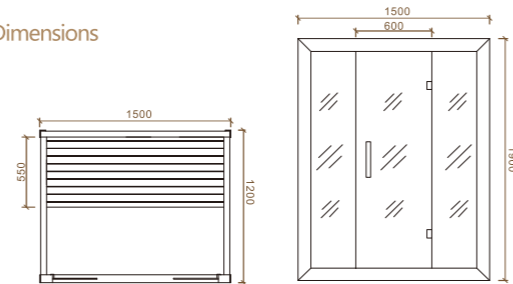

Features



Control System
Equipped with a smart control panel, you can effortlessly set your preferred settings for a personalized sauna session every time.



Infrared Heating
The sauna utilizes advanced infrared heating technology, which deeply penetrates the skin for a more effective and soothing experience.



Sauna Speaker
The built-in sauna sound system can play your favorite music or relaxation audio to further enhance the relaxation effect of the sauna.

Wood Colors



Hemlock

Red Cedar

Poplar



Have a conversation with yourself in the room, and bring clarity back to life

Nordic Log Sauna. Achieve Deep Detoxification in 15 Minutes
and Maintain a Light and Refreshed State for 48 Hours.



INFRARED HEATING BOARD

The America space agency's experiment of the survival condition in the spaceship told the truth that the far infrared between 5.6 and 15 micron in the sunlight is the essential factor of survival. So this frequency band of light is named as "The Light of Life". Nowadays, this type of magical light wave has broken through limitation of medical science, OCEAN FUTURE is a producer of far infrared sauna rooms, we use this light of life to show three effects of far infrared's core technology.

Infrared Sauna Room OFS03-1



Specification

Size	W1000*D1050*H1900mm
Wood	Hemlock/Red Cedar/Poplar
Control System	1set (FM, Bluetooth, USB, WIFI)
Heating System	Far Infrared Heating Plate
Speaker	2pcs
Square Colorful Lamp	1pc
Colorful Light Belt	1set
Door Eaves Lighting	1pc
Wood Handle	1pc
Tempered Glass	1set
Total Power	1666W
Capacity	1 People

Product Characteristics

- High Quality Wood
- Brilliant Lighting
- Infrared Heating
- Intelligent Control
- High Efficiency Heating
- Perfect Accessories

Dimensions

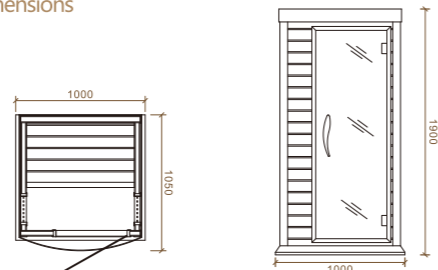

Features



Control System

Equipped with a smart control panel, you can effortlessly set your preferred settings for a personalized sauna session every time.



Infrared Heating

The sauna utilizes advanced infrared heating technology, which deeply penetrates the skin for a more effective and soothing experience.



Sauna Speaker

The built-in sauna sound system can play your favorite music or relaxation audio to further enhance the relaxation effect of the sauna.

Wood Colors



Hemlock

Red Cedar

Poplar

Infrared Sauna Room OFS03-2

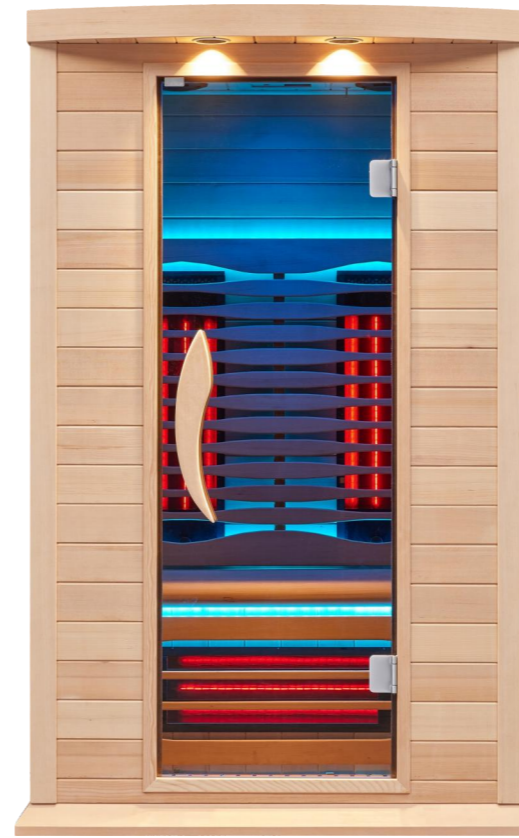

Specification

Size	W1200*D1050*H1900mm
Wood	Hemlock/Red Cedar/Poplar
Control System	1set (FM, Bluetooth, USB, WIFI)
Heating System	Far Infrared Heating Plate
Speaker	2pcs
Square Colorful Lamp	1pc
Colorful Light Belt	1set
Door Eaves Lighting	1pc
Wood Handle	1pc
Tempered Glass	1set
Total Power	2000W
Capacity	2 People

Product Characteristics

- High Quality Wood
- Brilliant Lighting
- Infrared Heating
- Intelligent Control
- High Efficiency Heating
- Perfect Accessories

Dimensions

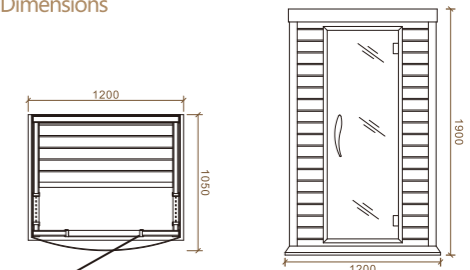

Features

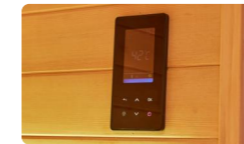

Control System

Equipped with a smart control panel, you can effortlessly set your preferred settings for a personalized sauna session every time.



Infrared Heating

The sauna utilizes advanced infrared heating technology, which deeply penetrates the skin for a more effective and soothing experience.



Sauna Speaker

The built-in sauna sound system can play your favorite music or relaxation audio to further enhance the relaxation effect of the sauna.

Wood Colors



Hemlock

Red Cedar

Poplar

Infrared Sauna Room OFS03-3

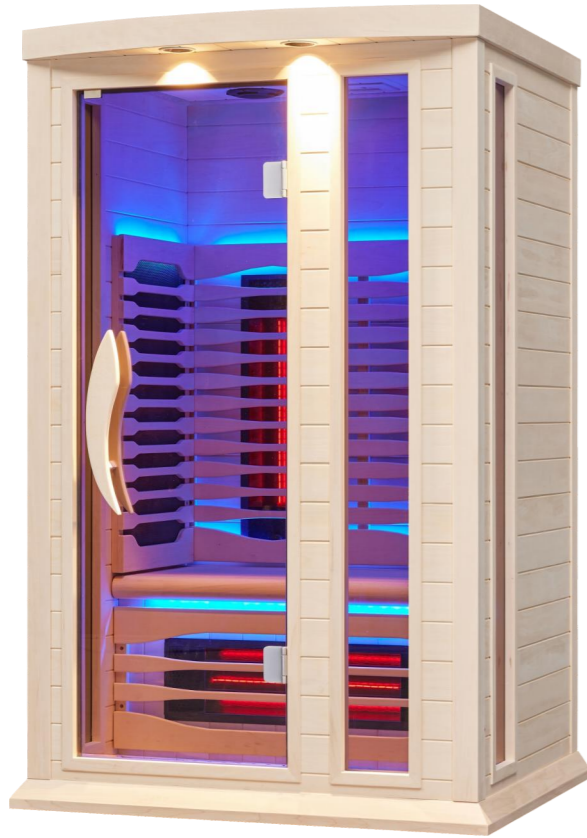

Specification

Size	W1200*D1050*H1900mm
Wood	Hemlock/Red Cedar/Poplar
Control System	1set (FM, Bluetooth, USB, WIFI)
Heating System	Far Infrared Heating Plate
Speaker	2pcs
Square Colorful Lamp	1pc
Colorful Light Belt	1set
Door Eaves Lighting	1pc
Wood Handle	1pc
Tempered Glass	1set
Total Power	2000W
Capacity	3 People

Product Characteristics

- High Quality Wood
- Brilliant Lighting
- Infrared Heating
- Intelligent Control
- High Efficiency Heating
- Perfect Accessories

Dimensions

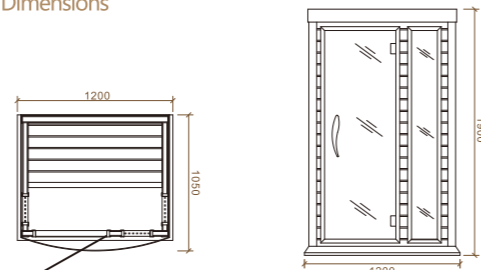

Features



Control System

Equipped with a smart control panel, you can effortlessly set your preferred settings for a personalized sauna session every time.



Infrared Heating

The sauna utilizes advanced infrared heating technology, which deeply penetrates the skin for a more effective and soothing experience.



Sauna Speaker

The built-in sauna sound system can play your favorite music or relaxation audio to further enhance the relaxation effect of the sauna.

Wood Colors



Hemlock

Red Cedar

Poplar

Infrared Sauna Room OFS03-4



Specification

Size	W1500*D1200*H1900mm
Wood	Hemlock/Red Cedar/Poplar
Control System	1set (FM, Bluetooth, USB, WIFI)
Heating System	Far Infrared Heating Plate
Speaker	2pcs
Square Colorful Lamp	1pc
Colorful Light Belt	1set
Door Eaves Lighting	1pc
Wood Handle	1pc
Tempered Glass	1set
Total Power	2400W
Capacity	3People

Product Characteristics

- High Quality Wood
- Brilliant Lighting
- Infrared Heating
- Intelligent Control
- High Efficiency Heating
- Perfect Accessories

Dimensions

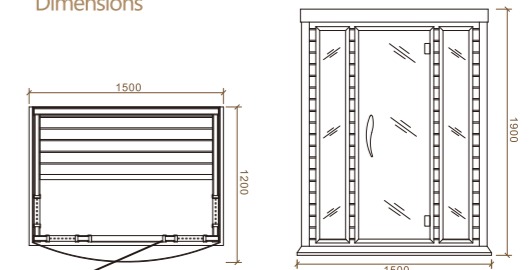

Features



Control System

Equipped with a smart control panel, you can effortlessly set your preferred settings for a personalized sauna session every time.



Infrared Heating

The sauna utilizes advanced infrared heating technology, which deeply penetrates the skin for a more effective and soothing experience.



Sauna Speaker

The built-in sauna sound system can play your favorite music or relaxation audio to further enhance the relaxation effect of the sauna.

Wood Colors



Hemlock

Red Cedar

Poplar

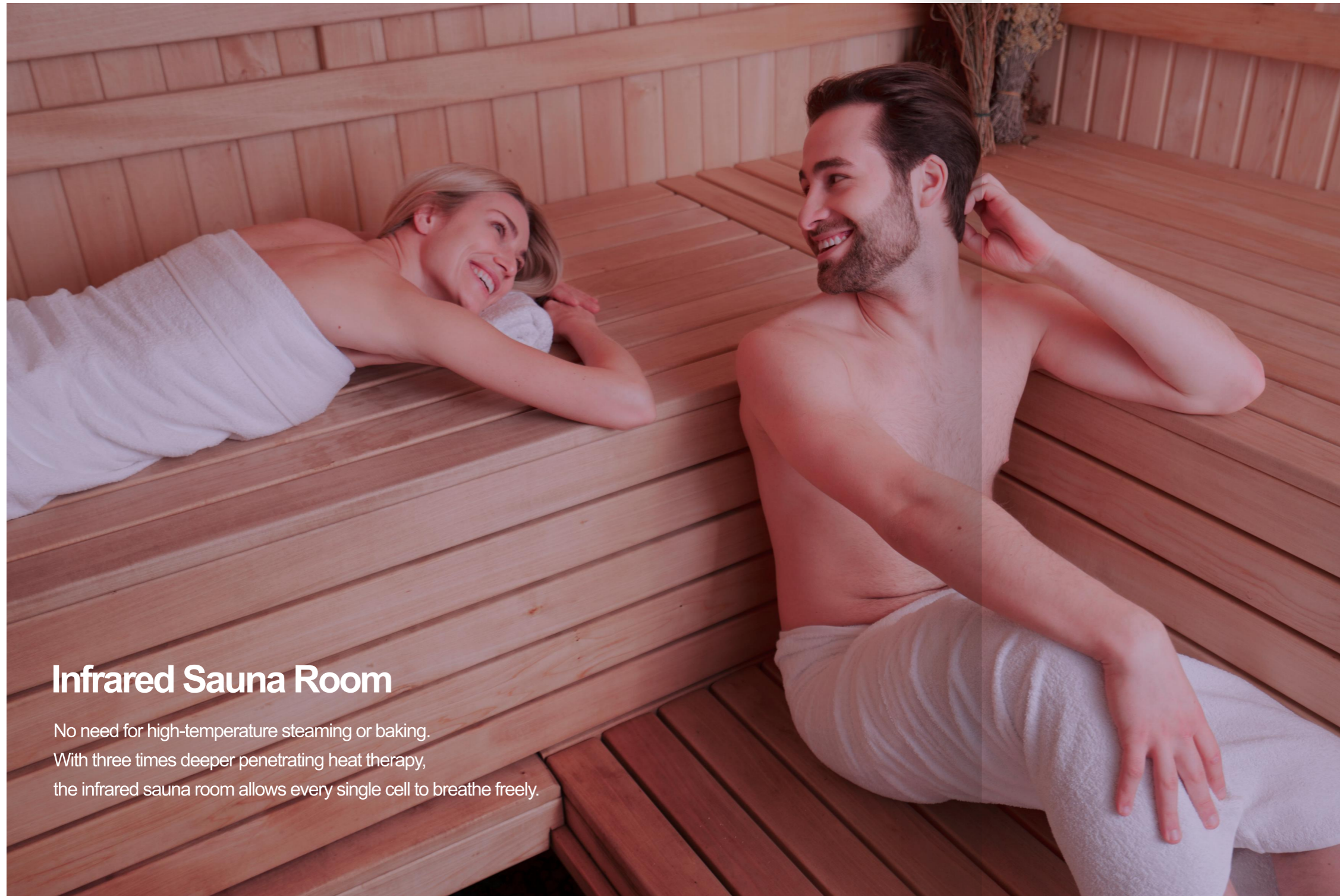

Infrared Sauna Room

No need for high-temperature steaming or baking. With three times deeper penetrating heat therapy, the infrared sauna room allows every single cell to breathe freely.



Infrared Sauna Room OFS07-1



Specification

Size	W1800*D1800*H2100mm
Wood	Hemlock/Red Cedar/Poplar
Control System	1set (FM, Bluetooth, USB, WIFI)
Heating System	Far infrared+Stove
Harvia Stove	8kW
Speaker	2pcs
Colorful Lamp	1pc
Light	1set
Sauna Stone	1set
Wooden Stove Frame	1set
Wood Handle	1pc
Tempered Glass	1set
Total Power	8000W
Capacity	4~5 People

Product Characteristics

- High Quality Wood
- Brilliant Lighting
- Infrared Heating
- Intelligent Control
- High Efficiency Heating
- Perfect Accessories

Dimensions

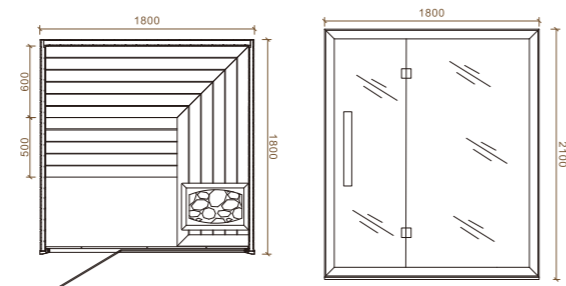

Features



Wooden Stove Frame
The wooden frame not only supports efficient heat distribution but also blends seamlessly with the natural wood interior.



Control System
Equipped with an intelligent control panel that can accurately adjust temperature, humidity, and lighting.



Sauna Speaker
The built-in sauna sound system can play your favorite music or relaxation audio to further enhance the relaxation effect of the sauna.

Wood Colors

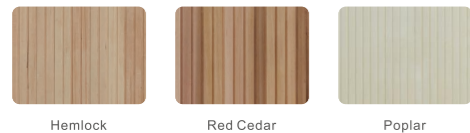

Hemlock

Red Cedar

Poplar

Infrared Sauna Room OFS07-2



Specification

Size	W1800*D1800*H2100mm
Wood	Hemlock/Red Cedar/Poplar
Control System	1set (FM, Bluetooth, USB, WIFI)
Heating System	Far infrared+Stove
Harvia Stove	8kW
Speaker	2pcs
Colorful Lamp	1pc
Light	1set
Sauna Stone	1set
Wooden Stove Frame	1set
Wood Handle	1pc
Tempered Glass	1set
Total Power	8000W
Capacity	4~5 People

Product Characteristics

- High Quality Wood
- Brilliant Lighting
- Infrared Heating
- Intelligent Control
- High Efficiency Heating
- Perfect Accessories

Dimensions

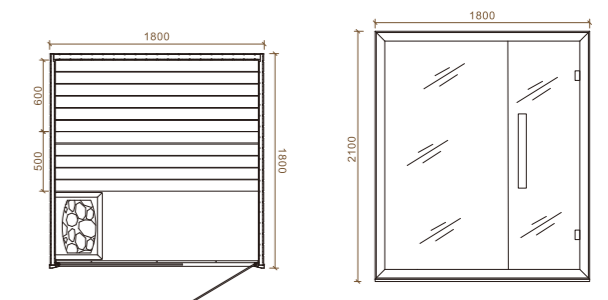

Features



Wooden Stove Frame
The wooden frame not only supports efficient heat distribution but also blends seamlessly with the natural wood interior.

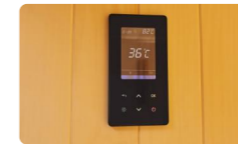

Control System
Equipped with an intelligent control panel that can accurately adjust temperature, humidity, and lighting.



Sauna Speaker
The built-in sauna sound system can play your favorite music or relaxation audio to further enhance the relaxation effect of the sauna.

Wood Colors

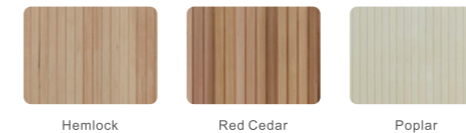

Hemlock

Red Cedar

Poplar







Infrared Sauna Room OFS08-1



Specification

Size	W1800*D1800*H2100mm
Wood	Hemlock/Red Cedar/Poplar
Control System	1set (FM, Bluetooth, USB, WIFI)
Heating System	Far infrared heating plate+box
Speaker	2pcs
Colorful Lamp	1pc
Light	1set
Sauna Stone	1set
Wooden Stove Frame	1set
Wood Handle	1pc
Tempered Glass	1set
Total Power	2900W
Capacity	4~5 People

Product Characteristics

-  High Quality Wood
-  Brilliant Lighting
-  Infrared Heating
-  Intelligent Control
-  High Efficiency Heating
-  Perfect Accessories

Dimensions

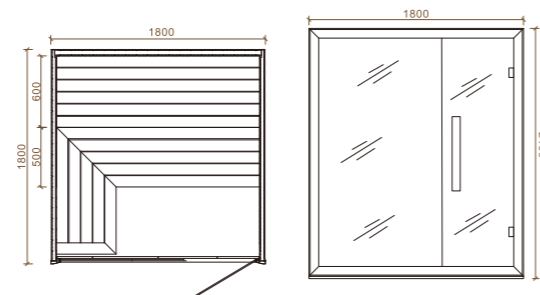

Features



Wooden Stove Frame
The wooden frame not only supports efficient heat distribution but also blends seamlessly with the natural wood interior.



Control System
Equipped with an intelligent control panel that can accurately adjust temperature, humidity, and lighting.



Sauna Speaker
The built-in sauna sound system can play your favorite music or relaxation audio to further enhance the relaxation effect of the sauna.

Wood Colors



Hemlock

Red Cedar

Poplar



Traditional Sauna Room

The interior of the sauna is designed with logs and natural stone, as if it were one with nature.

Bringing You the Best Traditional Sauna Experience

Our traditional sauna rooms are equipped with energy-efficient stoves that not only heat up quickly and maintain a stable temperature, but also provide a warm and comfortable steam experience continuously, so that you can enjoy constant heat throughout the use process, further enhancing your enjoyment experience.

Through the effect of high-temperature steam, the traditional sauna can effectively open the pores, promote the discharge of sweat, and accelerate the body's detoxification process. It helps to remove toxins accumulated in the body and enhances metabolism by promoting blood circulation.

In addition, our traditional sauna rooms use classic wooden structures, combining the warmth and natural smell of natural wood to create a peaceful and relaxing atmosphere. The natural texture and fresh aroma of wood can bring a deep relaxation experience and effectively relieve daily stress.

Each traditional sauna room uses high-quality wood and advanced heating elements to ensure durability and long-term reliability. In addition, all our sauna rooms have passed strict quality inspections and meet international safety standards, so that users can enjoy the sauna without worries and experience every use with peace of mind.



TRADITIONAL SAUNA

A Revitalizing Ritual Honed by Millennia of Wellness Wisdom

In the steamy embrace of a wooden sanctuary, where sweat glistens on the skin, lies a timeless human ritual of purification. The traditional sauna is more than a retreat for relaxation—it's a natural healing ceremony that awakens vitality. Its unique dry heat environment and high-temperature effects offer modern users profound, multilayered health benefits that work from the outside in.

CHOOSE LEGACY CHOOSE EXCELLENCE

Crafted with Nordic century-old techniques, our traditional saunas feature premium red cedar wood for natural aromatherapy and intelligent temperature control (58-90°C/136-194°F). Whether for home wellness or commercial spaces, they bridge ancient healing wisdom with modern living.

Let every breath become healing, every drop of sweat carry renewal—experience the timeless magic of the traditional sauna.

6 Science-Backed Benefits of Traditional Sauna

- Deep Detoxification, Total Purification:**
The dry heat environment (around 70°C/158°F) accelerates metabolism, triggering pores to open fully. Sweat production can triple compared to daily activity, flushing out metabolic waste (lactic acid, urea) and environmental toxins (heavy metals, chemical residues) for a true "deep cleanse."
- Strengthened Heart and Cardiovascular Protection:**
High temperatures elevate heart rates to levels similar to moderate exercise (120-150 BPM), enhancing vascular elasticity. Finnish studies reveal that 4-7 weekly sauna sessions reduce cardiovascular disease risk by 27%, earning it the title of "passive cardio workout."
- Chronic Pain Relief, Body Rejuvenation:**
Penetrating heat loosens muscle fascia and boosts localized blood flow, alleviating back pain, arthritis, and joint stiffness. A natural "muscle recovery chamber" for desk workers and athletes alike.
- Skin Revitalization, Natural Beauty Therapy:**
Heat accelerates skin cell turnover, while sweat rinses away oil and dead cells, refining pores. Regular use reduces cellulite and imparts a healthy glow—a chemical-free "thermal SPA."
- Immune System Optimization:**
Every 1°C rise in body temperature boosts immunity by 5-6 times. Sauna-induced "artificial fever" activates white blood cells, strengthening antiviral defenses—ideal for seasonal immunity boosts.
- Stress Relief and Mind-Body Harmony:**
Heat triggers endorphin release, reducing cortisol (stress hormone) levels by 20% in just 15 minutes. Paired with birch aromas and serene ambiance, it's nature's prescription for anxiety relief and deeper sleep.

Welcome To Ultimate Sauna World...

More and more users favor the perfect enjoy from Ocean Future sauna room. It shows the OCEAN FUTURE spirit of chasing perfect products & our profound concern for the users.

Traditional Sauna Room



Traditional Sauna Room OFS04-1



Specification

Size	W2100*D1600*H2000mm
Wood	Hemlock/Red Cedar/Poplar
Control System	1set (FM, Bluetooth, USB, WIFI)
Harvia Stove	8kW
Speaker	2pcs
Colorful Lamp	1pc
Light	1set
Wooden Stove Frame	1set
Wood Handle	1pc
Tempered Glass	1set
Total Power	8000W
Capacity	5 People

Product Characteristics

- High Quality Wood
- Brilliant Lighting
- Infrared Heating
- Intelligent Control
- High Efficiency Heating
- Perfect Accessories

Dimensions

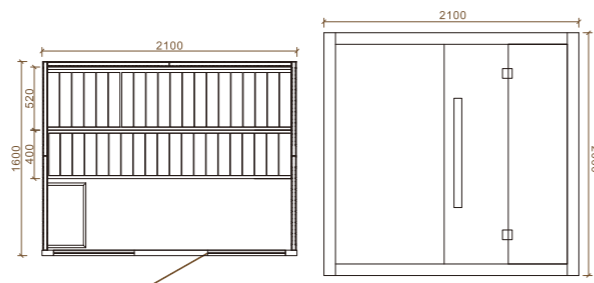

Features



Wooden Stove Frame
The carefully designed wooden stove frame ensures the safety and stability of the heating stove.

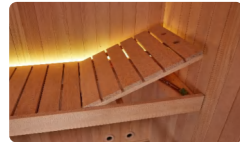

Premium Wood
The natural and beautiful wood texture exudes a light and elegant wood fragrance, which enhances the sauna experience.



Wet and dry bulb thermometer / Hourglass
Measuring humidity through the temperature difference between wet and dry bulbs. The hourglass, on the other hand, is for recording and controlling time.

Wood Colors



Hemlock

Red Cedar

Poplar

Traditional Sauna Room OFS04-2



Specification

Size	W2100*D1600*H2000mm
Wood	Hemlock/Red Cedar/Poplar
Control System	1set (FM, Bluetooth, USB, WIFI)
Harvia Stove	8kW
Speaker	2pcs
Colorful Lamp	1pc
Light	1set
Wooden Stove Frame	1set
Wood Handle	1pc
Tempered Glass	1set
Total Power	8000W
Capacity	5 People

Product Characteristics

- High Quality Wood
- Brilliant Lighting
- Infrared Heating
- Intelligent Control
- High Efficiency Heating
- Perfect Accessories

Dimensions

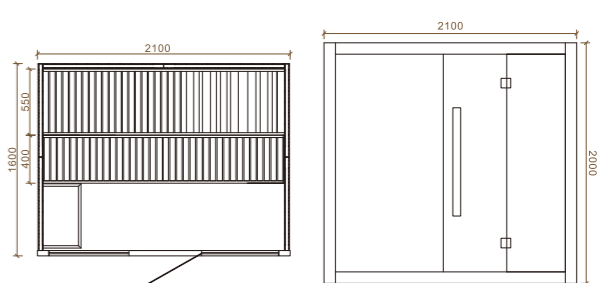

Features



Wooden Stove Frame
The carefully designed wooden stove frame ensures the safety and stability of the heating stove.



Premium Wood
The natural and beautiful wood texture exudes a light and elegant wood fragrance, which enhances the sauna experience.



Wet and dry bulb thermometer / Hourglass
Measuring humidity through the temperature difference between wet and dry bulbs. The hourglass, on the other hand, is for recording and controlling time.

Wood Colors



Hemlock

Red Cedar

Poplar

Every breath is a purification, and every drop of sweat is a new beginning.

Traditional saunas use high temperatures and the fragrance of wood to restart the balance of the body and mind.









Traditional Sauna Room OFS05-1



Specification

Size	W1800*D1800*H2100mm
Wood	Hemlock/Red Cedar/Poplar
Control System	1set (FM, Bluetooth, USB, WIFI)
Harvia Stove	8kW
Speaker	2pcs
Colorful Lamp	1pc
Light	1set
Wooden Stove Frame	1set
Wood Handle	1pc
Tempered Glass	1set
Total Power	8000W
Capacity	4 People

Product Characteristics

-  High Quality Wood
-  Brilliant Lighting
-  Infrared Heating
-  Intelligent Control
-  High Efficiency Heating
-  Perfect Accessories

Dimensions

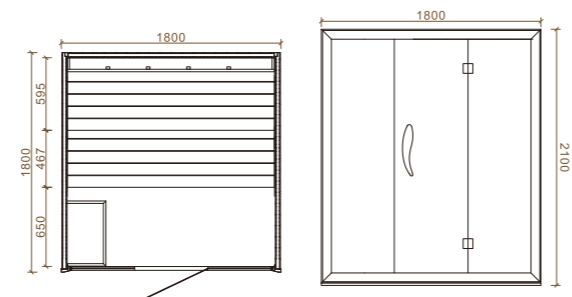

Features



Brilliant Lighting
High-quality LED lighting system provides soft and uniform lighting, creating a warm and relaxing sauna atmosphere.



Control System
Equipped with an intelligent control panel that can accurately adjust temperature, humidity, and lighting.



Wooden Stove Frame
The carefully designed wooden stove frame ensures the safety and stability of the heating stove.

Wood Colors



Hemlock

Red Cedar

Poplar



Traditional Sauna Room OFS05-2

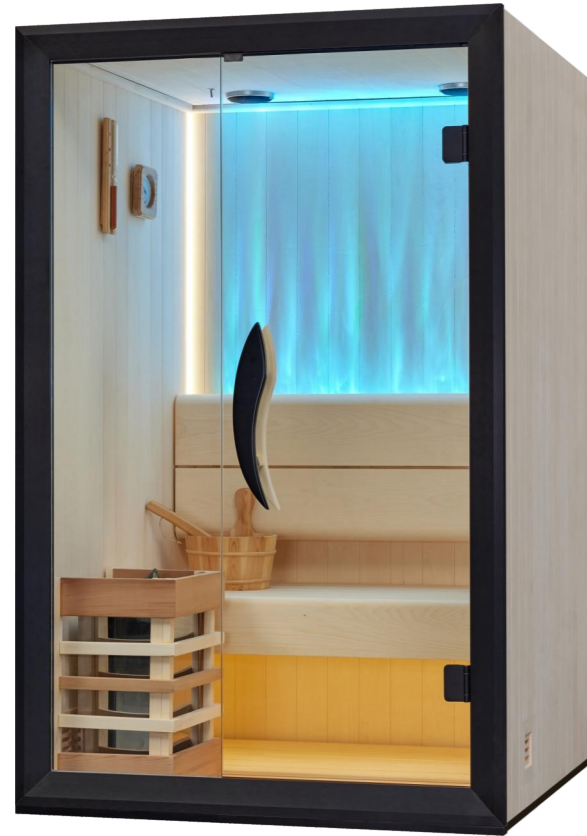

Specification

Size	W1200*D1200*H1900mm
Wood	Hemlock/Red Cedar/Poplar
Control System	1set (FM, Bluetooth, USB, WIFI)
Harvia Stove	3.5kW
Speaker	2pcs
Colorful Lamp	1pc
Light	1set
Wooden Stove Frame	1set
Wood Handle	1pc
Tempered Glass	1set
Total Power	3500W
Capacity	1 People

Product Characteristics

- High Quality Wood
- Brilliant Lighting
- Infrared Heating
- Intelligent Control
- High Efficiency Heating
- Perfect Accessories

Dimensions

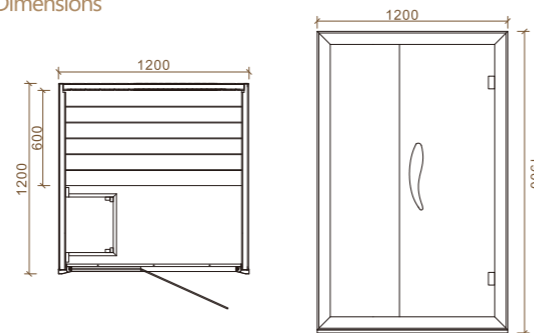

Features



Brilliant Lighting
High-quality LED lighting system provides soft and uniform lighting, creating a warm and relaxing sauna atmosphere.



Control System
Equipped with an intelligent control panel that can accurately adjust temperature, humidity, and lighting.



Sauna Speaker
The built-in sauna sound system can play your favorite music or relaxation audio to further enhance the relaxation effect of the sauna.

Wood Colors



Hemlock

Red Cedar

Poplar

Traditional Sauna Room OFS05-3



Specification

Size	W1800*D1800*H2100mm
Wood	Hemlock/Red Cedar/Poplar
Control System	1set (FM, Bluetooth, USB, WIFI)
Harvia Stove	8kW
Speaker	2pcs
Colorful Lamp	1pc
Light	1set
Wooden Stove Frame	1set
Wood Handle	1pc
Tempered Glass	1set
Total Power	8000W
Capacity	4 People

Product Characteristics

- High Quality Wood
- Brilliant Lighting
- Infrared Heating
- Intelligent Control
- High Efficiency Heating
- Perfect Accessories

Dimensions

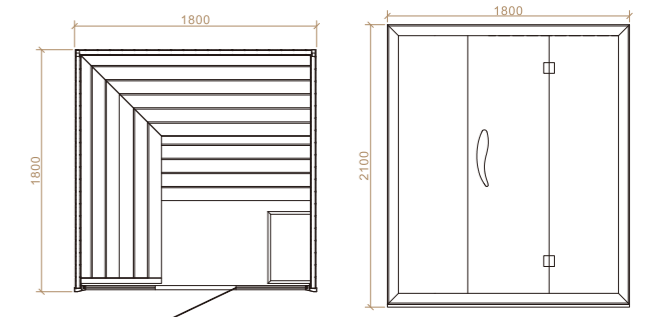

Features



Brilliant Lighting
High-quality LED lighting system provides soft and uniform lighting, creating a warm and relaxing sauna atmosphere.

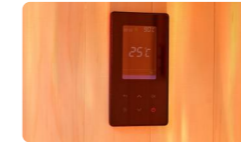

Control System
Equipped with an intelligent control panel that can accurately adjust temperature, humidity, and lighting.



Sauna Speaker
The built-in sauna sound system can play your favorite music or relaxation audio to further enhance the relaxation effect of the sauna.

Wood Colors



Hemlock

Red Cedar

Poplar



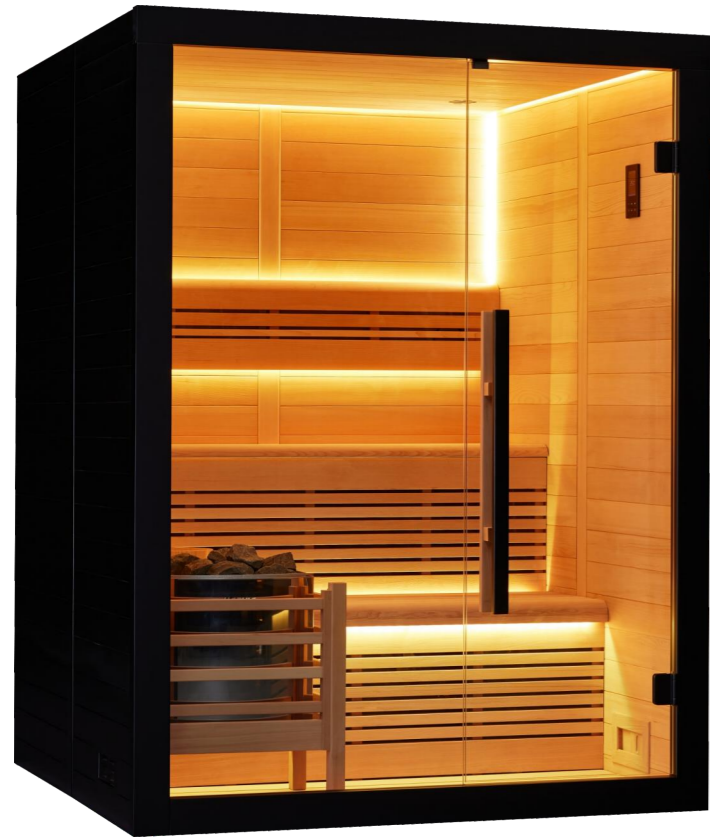



Traditional Sauna Room OFS12-2



Specification

Size	W1600*D1500*H2100mm
Wood	Hemlock/Red Cedar/Poplar
Control System	1set (FM, Bluetooth, USB, WIFI)
Heating System	Far infrared heating box
Harvia Stove	6kW
Speaker	2pcs
Colorful Lamp	1pc
Light	1set
Wooden Stove Frame	1set
Wood Handle	1pc
Tempered Glass	1set
Total Power	6000W
Capacity	4~5 People

Product Characteristics

-  High Quality Wood
-  Brilliant Lighting
-  Infrared Heating
-  Intelligent Control
-  High Efficiency Heating
-  Perfect Accessories

Dimensions

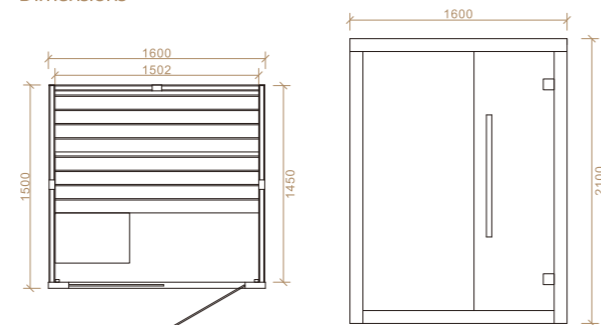

Features



Brilliant Lighting
High-quality LED lighting system provides soft and uniform lighting, creating a warm and relaxing sauna atmosphere.



Control System
Equipped with an intelligent control panel that can accurately adjust temperature, humidity, and lighting.



Wooden Stove Frame
The carefully designed wooden stove frame ensures the safety and stability of the heating stove.

Wood Colors



Hemlock

Red Cedar

Poplar



This product makes use of far - infrared technology, which can effectively boost blood circulation.

Far - infrared rays, with a wavelength ranging from 5 to 15 μ m, are capable of penetrating the skin to a depth of 3 - 5 cm. They directly heat the deep - seated tissues, activate the activity of cellular mitochondria, and facilitate the expulsion of fat - soluble toxins, such as heavy metals and pesticide residues, through sweat.

Infrared Sauna Room OFS06A-1



Specification

Size	W900*D1000*H1900mm
Wood	Hemlock/Red Cedar/Poplar
Control System	1set (FM, Bluetooth, USB)
Heating System	Far infrared heating plate
Speaker	2pcs
Square Colorful Lamp	1pc
Colorful Light Belt	Roof, backrest, seat board
Wood Handle	1pc
Tempered Glass	Dark Brown
Total Power	1400W
Capacity	1 People

Product Characteristics

- High Quality Wood
- Brilliant Lighting
- Infrared Heating
- Intelligent Control
- High Efficiency Heating
- Perfect Accessories

Dimensions

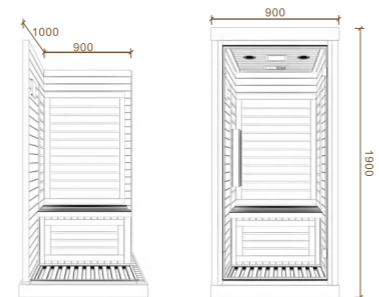

Features



Control System
Equipped with an intelligent control panel that can accurately adjust temperature, humidity, and lighting.



Infrared Heating
The sauna utilizes advanced infrared heating technology, which deeply penetrates the skin for a more effective and soothing experience.



Sauna Speaker
The built-in sauna sound system can play your favorite music or relaxation audio to further enhance the relaxation effect of the sauna.

Wood Colors



Hemlock Red Cedar Poplar

Infrared Sauna Room OFS06A-2



Specification

Size	W1200*D1050*H1900mm
Wood	Hemlock/Red Cedar/Poplar
Control System	1set (FM, Bluetooth, USB)
Heating System	Far infrared heating plate
Speaker	2pcs
Square Colorful Lamp	1pc
Colorful Light Belt	Roof, backrest, seat board
Wood Handle	1pc
Tempered Glass	Dark Brown
Total Power	1800W
Capacity	2 People

Product Characteristics

- High Quality Wood
- Brilliant Lighting
- Infrared Heating
- Intelligent Control
- High Efficiency Heating
- Perfect Accessories

Dimensions

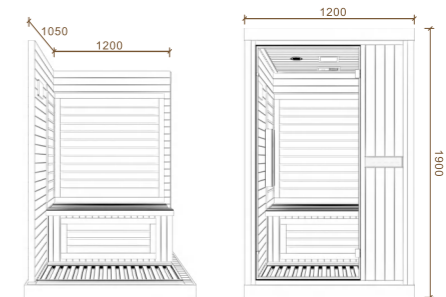

Features



Control System
Equipped with an intelligent control panel that can accurately adjust temperature, humidity, and lighting.

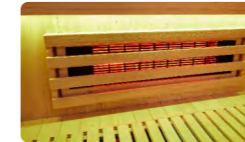

Infrared Heating
The sauna utilizes advanced infrared heating technology, which deeply penetrates the skin for a more effective and soothing experience.



Sauna Speaker
The built-in sauna sound system can play your favorite music or relaxation audio to further enhance the relaxation effect of the sauna.

Wood Colors



Hemlock Red Cedar Poplar

Infrared Sauna Room OFS06A-3-1

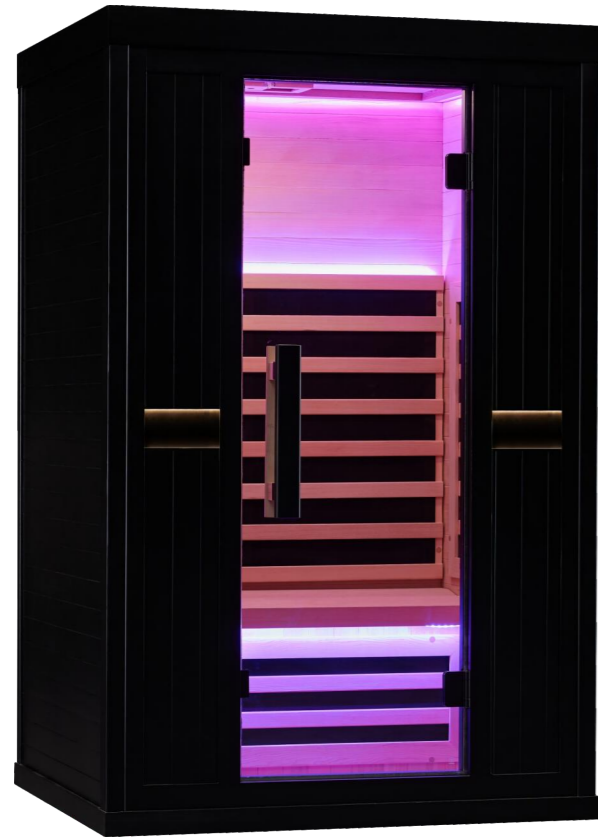

Specification

Size	W1200*D1050*H1900mm
Wood	Hemlock/Red Cedar/Poplar
Control System	1set (FM, Bluetooth, USB)
Heating System	Far infrared heating plate
Speaker	2pcs
Square Colorful Lamp	1pc
Colorful Light Belt	Roof, backrest, seat board
Wood Handle	1pc
Tempered Glass	Dark Brown
Total Power	1800W
Capacity	2 People

Product Characteristics

- High Quality Wood
- Brilliant Lighting
- Infrared Heating
- Intelligent Control
- High Efficiency Heating
- Perfect Accessories

Dimensions

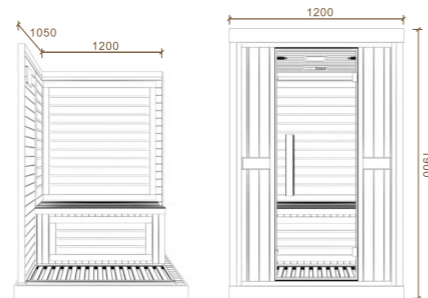

Features



Control System

Equipped with an intelligent control panel that can accurately adjust temperature, humidity, and lighting.



Infrared Heating

The sauna utilizes advanced infrared heating technology, which deeply penetrates the skin for a more effective and soothing experience.



Sauna Speaker

The built-in sauna sound system can play your favorite music or relaxation audio to further enhance the relaxation effect of the sauna.

Wood Colors



Hemlock

Red Cedar

Poplar

Infrared Sauna Room OFS06A-3-2



Specification

Size	W1600*D1200*H1900mm
Wood	Hemlock/Red Cedar/Poplar
Control System	1set (FM, Bluetooth, USB)
Heating System	Far infrared heating plate
Speaker	2pcs
Square Colorful Lamp	1pc
Colorful Light Belt	Roof, backrest, seat board
Wood Handle	1pc
Tempered Glass	Dark Brown
Total Power	2800W
Capacity	2 People

Product Characteristics

- High Quality Wood
- Brilliant Lighting
- Infrared Heating
- Intelligent Control
- High Efficiency Heating
- Perfect Accessories

Dimensions

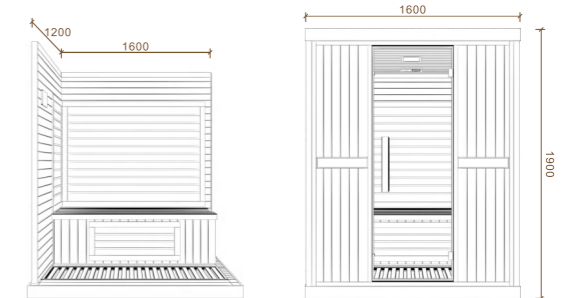

Features



Control System

Equipped with an intelligent control panel that can accurately adjust temperature, humidity, and lighting.



Infrared Heating

The sauna utilizes advanced infrared heating technology, which deeply penetrates the skin for a more effective and soothing experience.



Sauna Speaker

The built-in sauna sound system can play your favorite music or relaxation audio to further enhance the relaxation effect of the sauna.

Wood Colors



Hemlock

Red Cedar

Poplar

Infrared Sauna Room OFS06A-4



Specification

Size	W1600*D1200*H1900mm
Wood	Hemlock/Red Cedar/Poplar
Control System	1set (FM, Bluetooth, USB)
Heating System	Far infrared heating plate
Speaker	2pcs
Square Colorful Lamp	1pc
Colorful Light Belt	Roof, backrest, seat board
Wood Handle	1pc
Tempered Glass	Dark Brown
Total Power	2800W
Capacity	3-4 People

Product Characteristics

- High Quality Wood
- Brilliant Lighting
- Infrared Heating
- Intelligent Control
- High Efficiency Heating
- Perfect Accessories

Dimensions

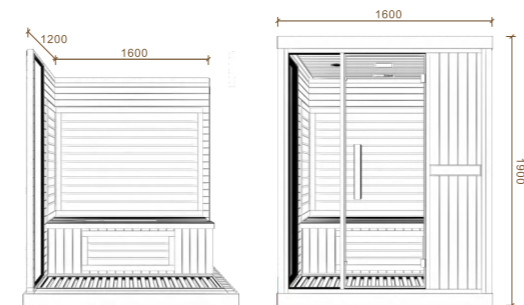

Features



Control System
Equipped with an intelligent control panel that can accurately adjust temperature, humidity, and lighting.



Infrared Heating
The sauna utilizes advanced infrared heating technology, which deeply penetrates the skin for a more effective and soothing experience.



Sauna Speaker
The built-in sauna sound system can play your favorite music or relaxation audio to further enhance the relaxation effect of the sauna.

Wood Colors



Hemlock

Red Cedar

Poplar

Infrared Sauna Room OFS06A-5



Specification

Size	W2100*D1500*H1900mm
Wood	Hemlock/Red Cedar/Poplar
Control System	1set (FM, Bluetooth, USB)
Heating System	Far infrared heating plate
Speaker	2pcs
Square Colorful Lamp	1pc
Colorful Light Belt	Roof, backrest, seat board
Wood Handle	1pc
Tempered Glass	Dark Brown
Total Power	4500W
Capacity	5-6 People

Product Characteristics

- High Quality Wood
- Brilliant Lighting
- Infrared Heating
- Intelligent Control
- High Efficiency Heating
- Perfect Accessories

Dimensions



Features



Control System
Equipped with an intelligent control panel that can accurately adjust temperature, humidity, and lighting.



Infrared Heating
The sauna utilizes advanced infrared heating technology, which deeply penetrates the skin for a more effective and soothing experience.



Sauna Speaker
The built-in sauna sound system can play your favorite music or relaxation audio to further enhance the relaxation effect of the sauna.

Wood Colors



Hemlock

Red Cedar

Poplar

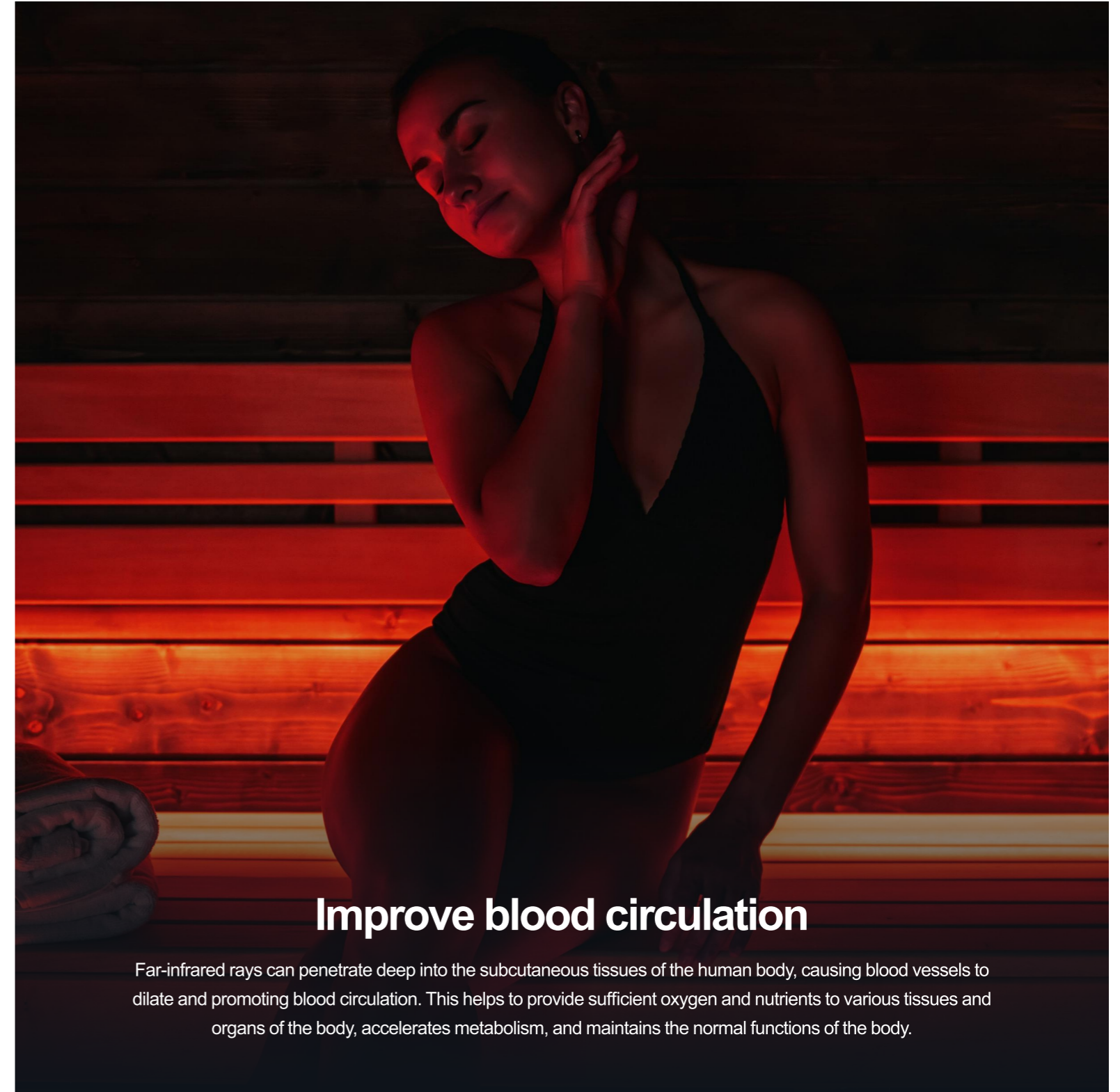

Improve blood circulation

Far-infrared rays can penetrate deep into the subcutaneous tissues of the human body, causing blood vessels to dilate and promoting blood circulation. This helps to provide sufficient oxygen and nutrients to various tissues and organs of the body, accelerates metabolism, and maintains the normal functions of the body.

Infrared Sauna Room OFS06B-1

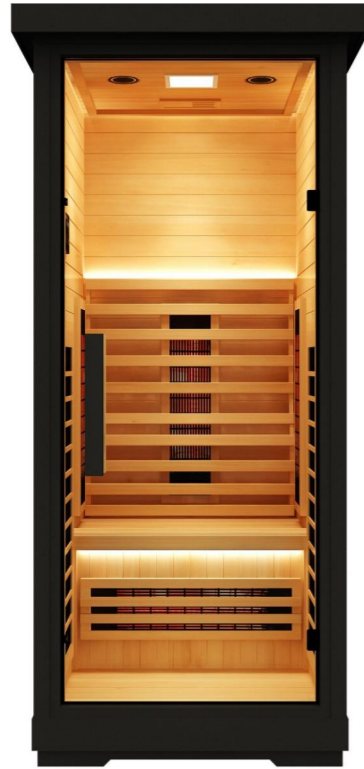

Specification

Size	W900*D1000*H1900mm
Wood	Hemlock/Red Cedar/Poplar
Control System	1set (FM, Bluetooth, USB)
Heating System	Far infrared heating plate+box
Speaker	2pcs
Square Colorful Lamp	1pc
Colorful Light Belt	Roof, backrest, seat board
Wood Handle	1pc
Tempered Glass	Dark Brown
Total Power	1400W
Capacity	1 People

Product Characteristics

- High Quality Wood
- Brilliant Lighting
- Infrared Heating
- Intelligent Control
- High Efficiency Heating
- Perfect Accessories

Dimensions

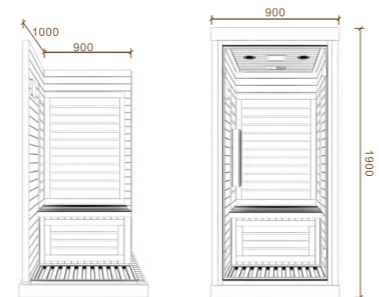

Features



Control System

Equipped with an intelligent control panel that can accurately adjust temperature, humidity, and lighting.



Infrared Heating

The sauna utilizes advanced infrared heating technology, which deeply penetrates the skin for a more effective and soothing experience.



Sauna Speaker

The built-in sauna sound system can play your favorite music or relaxation audio to further enhance the relaxation effect of the sauna.

Wood Colors



Hemlock

Red Cedar

Poplar

Infrared Sauna Room OFS06B-2

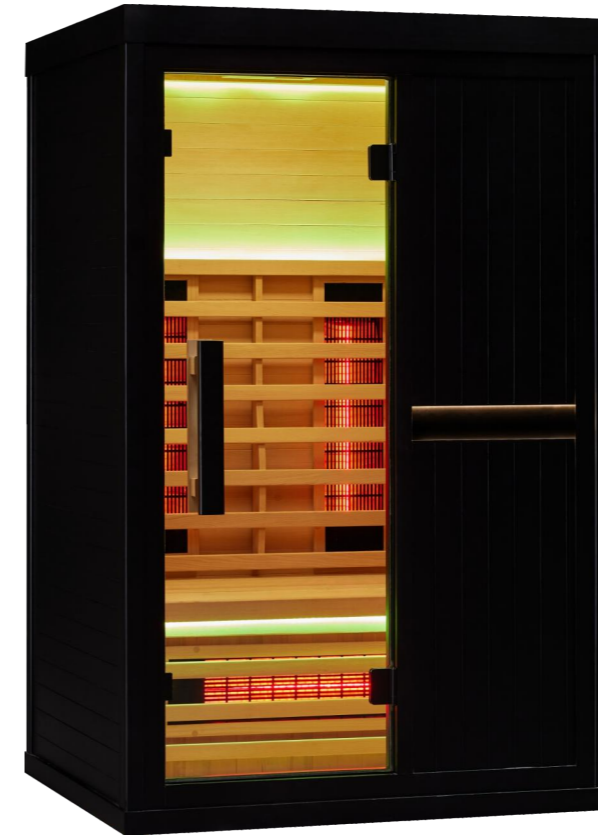

Specification

Size	W1200*D1050*H1900mm
Wood	Hemlock/Red Cedar/Poplar
Control System	1set (FM, Bluetooth, USB))
Heating System	Far infrared heating plate+box
Speaker	2pcs
Square Colorful Lamp	1pc
Colorful Light Belt	Roof, backrest, seat board
Wood Handle	1pc
Tempered Glass	Dark Brown
Total Power	1800W
Capacity	2 People

Product Characteristics

- High Quality Wood
- Brilliant Lighting
- Infrared Heating
- Intelligent Control
- High Efficiency Heating
- Perfect Accessories

Dimensions

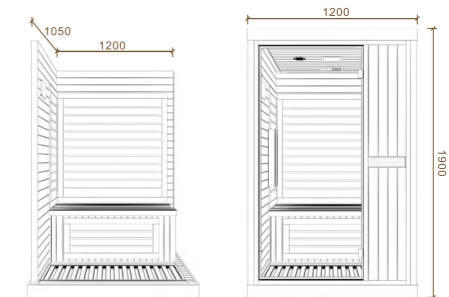

Features



Control System

Equipped with an intelligent control panel that can accurately adjust temperature, humidity, and lighting.



Infrared Heating

The sauna utilizes advanced infrared heating technology, which deeply penetrates the skin for a more effective and soothing experience.



Sauna Speaker

The built-in sauna sound system can play your favorite music or relaxation audio to further enhance the relaxation effect of the sauna.

Wood Colors



Hemlock

Red Cedar

Poplar

Infrared Sauna Room OFS06B-3-1

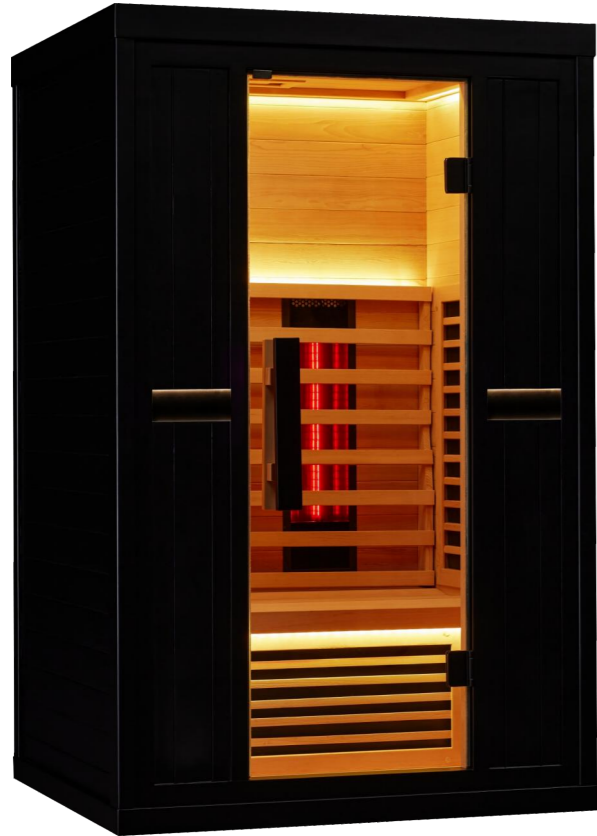

Specification

Size	W1200*D1050*H1900mm
Wood	Hemlock/Red Cedar/Poplar
Control System	1set (FM, Bluetooth, USB)
Heating System	Far infrared heating plate+box
Speaker	2pcs
Square Colorful Lamp	1pc
Colorful Light Belt	Roof, backrest, seat board
Wood Handle	1pc
Tempered Glass	Dark Brown
Total Power	1800W
Capacity	2 People

Product Characteristics

- High Quality Wood
- Brilliant Lighting
- Infrared Heating
- Intelligent Control
- High Efficiency Heating
- Perfect Accessories

Dimensions

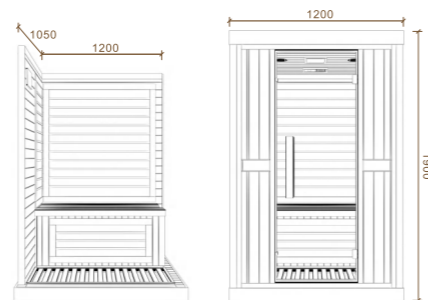

Features



Control System

Equipped with an intelligent control panel that can accurately adjust temperature, humidity, and lighting.



Infrared Heating

The sauna utilizes advanced infrared heating technology, which deeply penetrates the skin for a more effective and soothing experience.



Sauna Speaker

The built-in sauna sound system can play your favorite music or relaxation audio to further enhance the relaxation effect of the sauna.

Wood Colors



Hemlock

Red Cedar

Poplar

Infrared Sauna Room OFS06B-3-2



Specification

Size	W1600*D1200*H1900mm
Wood	Hemlock/Red Cedar/Poplar
Control System	1set (FM, Bluetooth, USB)
Heating System	Far infrared heating plate+box
Speaker	2pcs
Square Colorful Lamp	1pc
Colorful Light Belt	Roof, backrest, seat board
Wood Handle	1pc
Tempered Glass	Dark Brown
Total Power	2800W
Capacity	3-4 People

Product Characteristics

- High Quality Wood
- Brilliant Lighting
- Infrared Heating
- Intelligent Control
- High Efficiency Heating
- Perfect Accessories

Dimensions

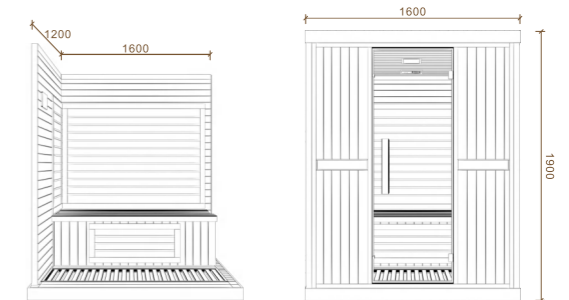

Features



Control System

Equipped with an intelligent control panel that can accurately adjust temperature, humidity, and lighting.



Infrared Heating

The sauna utilizes advanced infrared heating technology, which deeply penetrates the skin for a more effective and soothing experience.



Sauna Speaker

The built-in sauna sound system can play your favorite music or relaxation audio to further enhance the relaxation effect of the sauna.

Wood Colors



Hemlock

Red Cedar

Poplar

Infrared Sauna Room OFS06B-4



Specification

Size	W1600*D1200*H1900mm
Wood	Hemlock/Red Cedar/Poplar
Control System	1set (FM, Bluetooth, USB)
Heating System	Far infrared heating plate+box
Speaker	2pcs
Square Colorful Lamp	1pc
Colorful Light Belt	Roof, backrest, seat board
Wood Handle	1pc
Tempered Glass	Dark Brown
Total Power	2800W
Capacity	3-4 People

Product Characteristics

- High Quality Wood
- Brilliant Lighting
- Infrared Heating
- Intelligent Control
- High Efficiency Heating
- Perfect Accessories

Dimensions

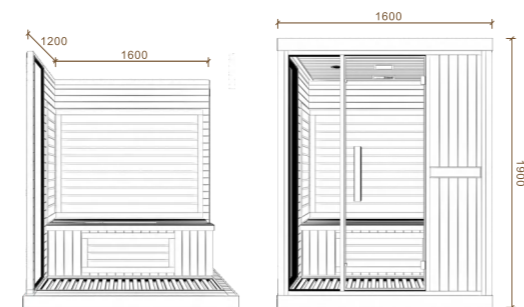

Features



Control System
Equipped with an intelligent control panel that can accurately adjust temperature, humidity, and lighting.



Infrared Heating
The sauna utilizes advanced infrared heating technology, which deeply penetrates the skin for a more effective and soothing experience.



Sauna Speaker
The built-in sauna sound system can play your favorite music or relaxation audio to further enhance the relaxation effect of the sauna.

Wood Colors

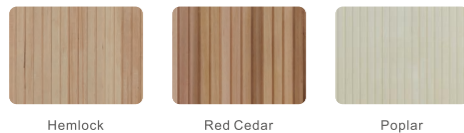

Hemlock

Red Cedar

Poplar

Infrared Sauna Room OFS06B-5



Specification

Size	W2100*D1500*H1900mm
Wood	Hemlock/Red Cedar/Poplar
Control System	1set (FM, Bluetooth, USB)
Heating System	Far infrared heating plate+box
Speaker	2pcs
Square Colorful Lamp	1pc
Colorful Light Belt	Roof, backrest, seat board
Wood Handle	1pc
Tempered Glass	Dark Brown
Total Power	4500W
Capacity	5-6 People

Product Characteristics

- High Quality Wood
- Brilliant Lighting
- Infrared Heating
- Intelligent Control
- High Efficiency Heating
- Perfect Accessories

Dimensions

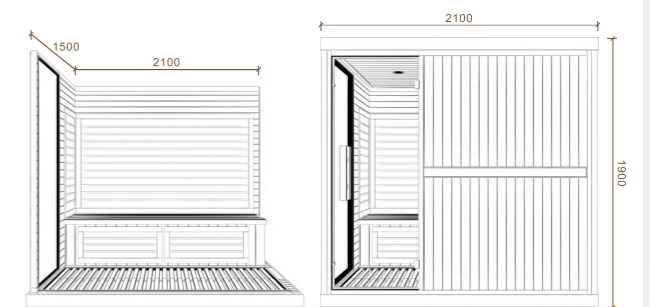

Features



Control System
Equipped with an intelligent control panel that can accurately adjust temperature, humidity, and lighting.



Infrared Heating
The sauna utilizes advanced infrared heating technology, which deeply penetrates the skin for a more effective and soothing experience.



Sauna Speaker
The built-in sauna sound system can play your favorite music or relaxation audio to further enhance the relaxation effect of the sauna.

Wood Colors

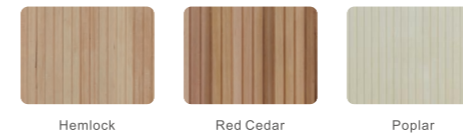

Hemlock

Red Cedar

Poplar

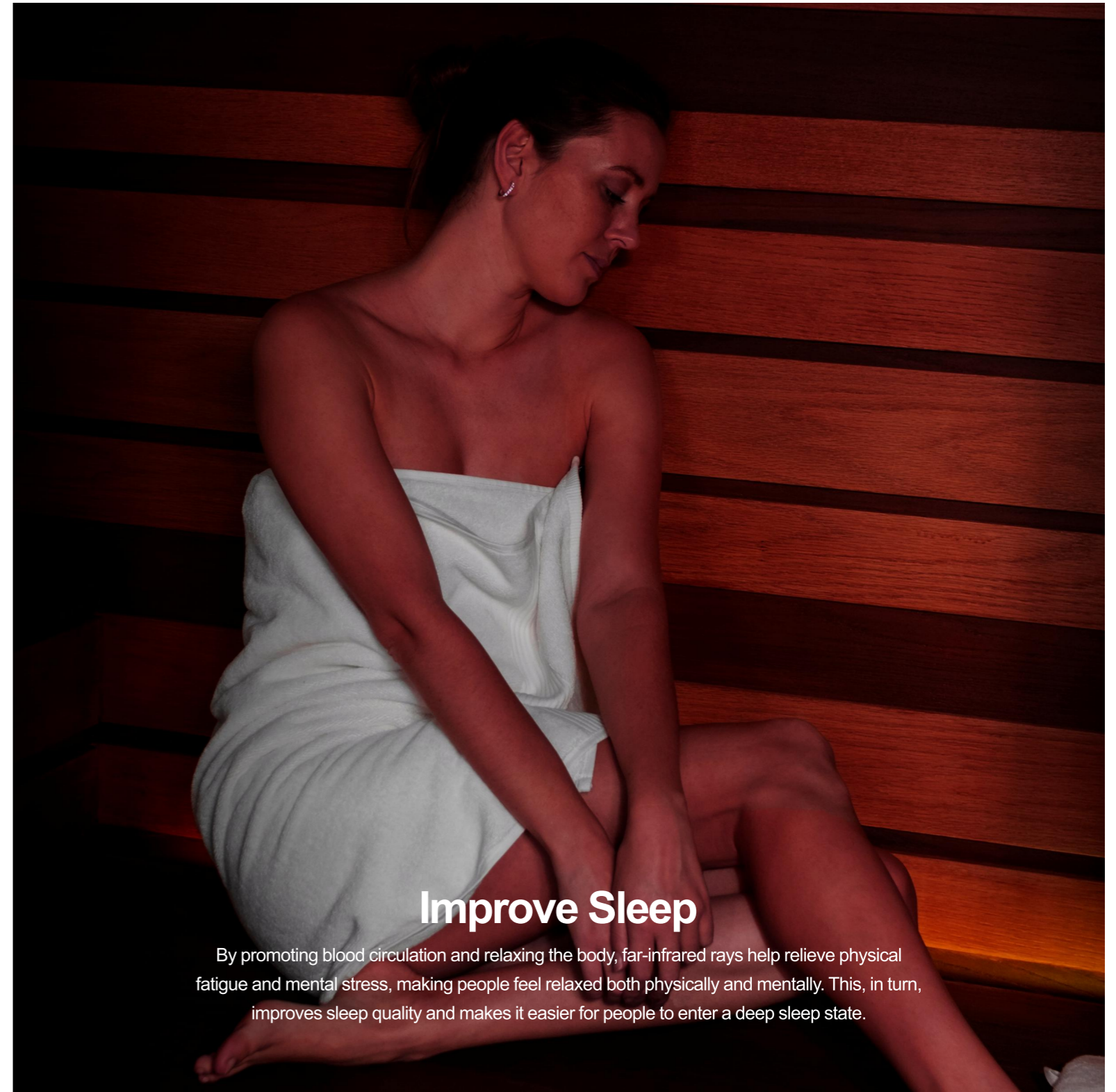

Improve Sleep

By promoting blood circulation and relaxing the body, far-infrared rays help relieve physical fatigue and mental stress, making people feel relaxed both physically and mentally. This, in turn, improves sleep quality and makes it easier for people to enter a deep sleep state.



OUTDOOR SAUNA ROOM

Bring a Nordic hot spring to your backyard

All-season outdoor sauna, unimpeded by wind and snow, offering a unique experience amidst the tranquility of nature.

Born for the outdoors, crafted for all four seasons

All-season

Winter insulation: 3-layer wall structure, reducing heat loss by 40%.

Summer insulation: The design of the top ventilation layer prevents exposure to direct sunlight and stuffiness.

Zero-maintenance wood

Imported heat-modified wood from Northern Europe.

No need for painting, corrosion prevention, or crack prevention.

Rapid warming

Exclusive outdoor dedicated stove.

The initial temperature is 26°C, rising to 75°C within 30+ minutes.

Viewing horizon

Double-layer Low-E low-emissivity glass.

Keep warm without fogging, and enjoy the scenery without it ending.

THERE ARE TWO COLORS TO CHOOSE FROM BLACK AND WHITE

Outdoor sauna is never just about heating the body

It is the warmth of a steaming cup on a snowy night, the relaxation of an autumn evening, and the awakening under the first ray of morning sunshine.
OCEAN FUTURE will create an outdoor private space for you that is usable all year round.



Product Detail Display



Wood Colors

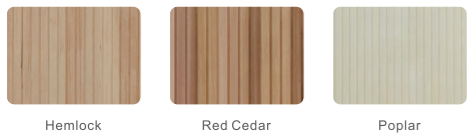

Hemlock Red Cedar Poplar

OFS05-3-T

Size	W2200*D2200*H2100mm
External Material	Aluminum Plastic Panel
Roof	Waterproofing Roof
Control System	MXD2022 (FM, Bluetooth, USB, WIFI)
Harvia stove	8 kW(BC80E)
Sauna Stone	1 set
Speaker	2 pcs
Colorful Lamp	Ripple crystal colored light
Wood Handle	1 pc
Glass Door	Tempered Glass
Total Power	8000W
Wooden bucket, spoon, Sandglass,hygrothermograph	

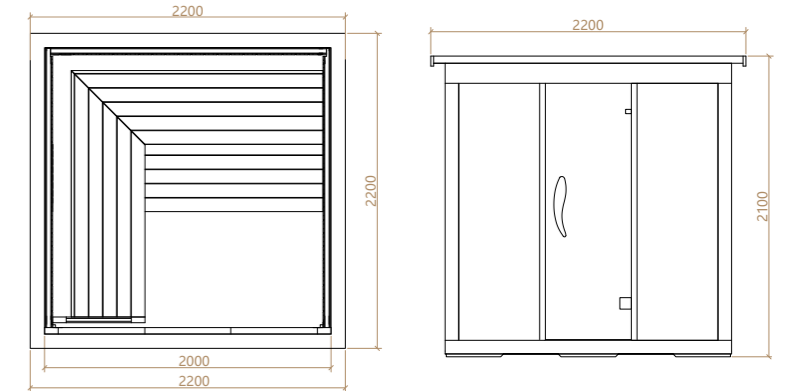

Outdoor Sauna Room OFS06C-1



Specification

Size	W900*D1000*H2100mm
Wood	Hemlock/Red Cedar/Poplar
Control System	1set (FM, Bluetooth, USB)
Heating System	Far infrared heating plate+box
Speaker	2pcs
Square Colorful Lamp	1pc
Colorful Light Belt	Roof, backrest, seat board
Wood Handle	1pc
Tempered Glass	Dark Brown
Total Power	1400W
Capacity	1 People

Product Characteristics

- High Quality Wood
- Brilliant Lighting
- Infrared Heating
- Intelligent Control
- High Efficiency Heating
- Perfect Accessories

Dimensions

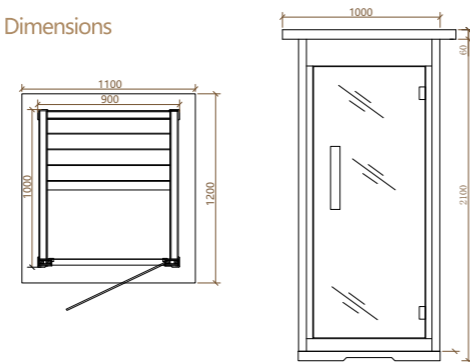

Features



Control System

Equipped with an intelligent control panel that can accurately adjust temperature, humidity, and lighting.



Infrared Heating

The sauna utilizes advanced infrared heating technology, which deeply penetrates the skin for a more effective and soothing experience.



Sauna Speaker

The built-in sauna sound system can play your favorite music or relaxation audio to further enhance the relaxation effect of the sauna.

Wood Colors



Hemlock

Red Cedar

Poplar 白松木

Outdoor Sauna Room OFS06C-2



Specification

Size	W1200*D1050*H2100mm
Wood	Hemlock/Red Cedar/Poplar
Control System	1set (FM, Bluetooth, USB))
Heating System	Far infrared heating plate+box
Speaker	2pcs
Square Colorful Lamp	1pc
Colorful Light Belt	Roof, backrest, seat board
Wood Handle	1pc
Tempered Glass	Dark Brown
Total Power	1800W
Capacity	2 People

Product Characteristics

- High Quality Wood
- Brilliant Lighting
- Infrared Heating
- Intelligent Control
- High Efficiency Heating
- Perfect Accessories

Dimensions

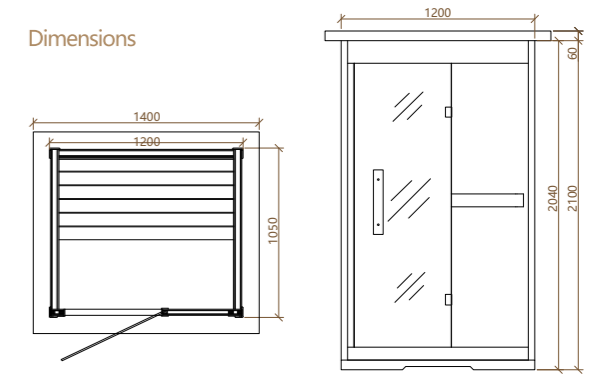

Features



Control System

Equipped with an intelligent control panel that can accurately adjust temperature, humidity, and lighting.



Infrared Heating

The sauna utilizes advanced infrared heating technology, which deeply penetrates the skin for a more effective and soothing experience.



Sauna Speaker

The built-in sauna sound system can play your favorite music or relaxation audio to further enhance the relaxation effect of the sauna.

Wood Colors



Hemlock

Red Cedar

Poplar

Outdoor Sauna Room OFS06C-3-1



Specification

Size	W1200*D1050*H2100mm
Wood	Hemlock/Red Cedar/Poplar
Control System	1set (FM, Bluetooth, USB)
Heating System	Far infrared heating plate+box
Speaker	2pcs
Square Colorful Lamp	1pc
Colorful Light Belt	Roof, backrest, seat board
Wood Handle	1pc
Tempered Glass	Dark Brown
Total Power	1800W
Capacity	2 People

Product Characteristics

- High Quality Wood
- Brilliant Lighting
- Infrared Heating
- Intelligent Control
- High Efficiency Heating
- Perfect Accessories

Dimensions

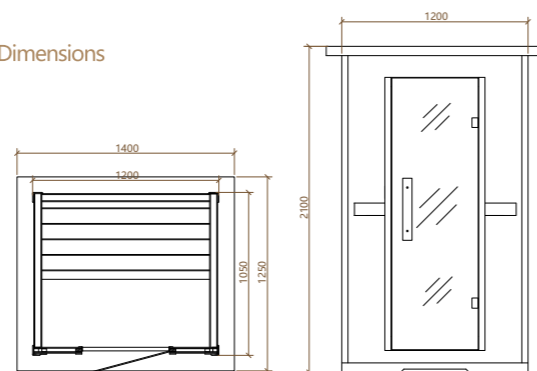

Features



Control System
Equipped with an intelligent control panel that can accurately adjust temperature, humidity, and lighting.



Infrared Heating
The sauna utilizes advanced infrared heating technology, which deeply penetrates the skin for a more effective and soothing experience.



Sauna Speaker
The built-in sauna sound system can play your favorite music or relaxation audio to further enhance the relaxation effect of the sauna.

Wood Colors



Hemlock Red Cedar Poplar

Outdoor Sauna Room OFS06C-3-2



Specification

Size	W1600*D1200*H2100mm
Wood	Hemlock/Red Cedar/Poplar
Control System	1set (FM, Bluetooth, USB)
Heating System	Far infrared heating plate+box
Speaker	2pcs
Square Colorful Lamp	1pc
Colorful Light Belt	Roof, backrest, seat board
Wood Handle	1pc
Tempered Glass	Dark Brown
Total Power	2800W
Capacity	3-4 People

Product Characteristics

- High Quality Wood
- Brilliant Lighting
- Infrared Heating
- Intelligent Control
- High Efficiency Heating
- Perfect Accessories

Dimensions

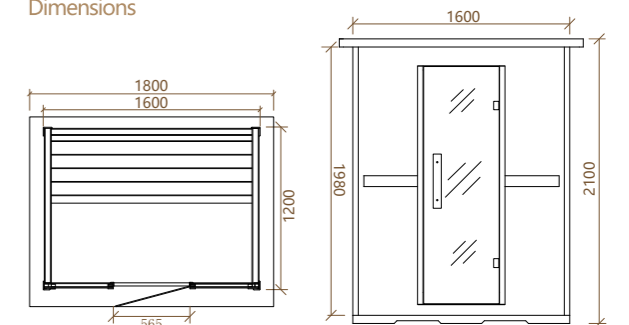

Features



Control System
Equipped with an intelligent control panel that can accurately adjust temperature, humidity, and lighting.



Infrared Heating
The sauna utilizes advanced infrared heating technology, which deeply penetrates the skin for a more effective and soothing experience.



Sauna Speaker
The built-in sauna sound system can play your favorite music or relaxation audio to further enhance the relaxation effect of the sauna.

Wood Colors



Hemlock Red Cedar Poplar

Outdoor Sauna Room OFS06C-4



Specification

Size	W1600*D1200*H2100mm
Wood	Hemlock/Red Cedar/Poplar
Control System	1set (FM, Bluetooth, USB)
Heating System	Far infrared heating plate+box
Speaker	2pcs
Square Colorful Lamp	1pc
Colorful Light Belt	Roof, backrest, seat board
Wood Handle	1pc
Tempered Glass	Dark Brown
Total Power	2800W
Capacity	3-4 People

Product Characteristics

- High Quality Wood
- Brilliant Lighting
- Infrared Heating
- Intelligent Control
- High Efficiency Heating
- Perfect Accessories

Dimensions

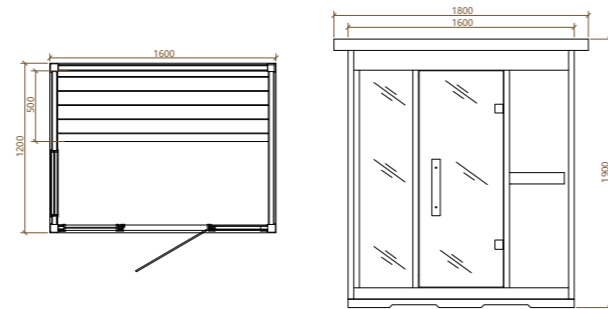

Features



Control System
Equipped with an intelligent control panel that can accurately adjust temperature, humidity, and lighting.



Infrared Heating
The sauna utilizes advanced infrared heating technology, which deeply penetrates the skin for a more effective and soothing experience.



Sauna Speaker
The built-in sauna sound system can play your favorite music or relaxation audio to further enhance the relaxation effect of the sauna.

Wood Colors

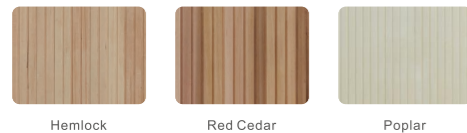

Hemlock

Red Cedar

Poplar

Outdoor Sauna Room OFS06C-5



Specification

Size	W2100*D1500*H2100mm
Wood	Hemlock/Red Cedar/Poplar
Control System	1set (FM, Bluetooth, USB)
Heating System	Far infrared heating plate+box
Speaker	2pcs
Square Colorful Lamp	1pc
Colorful Light Belt	Roof, backrest, seat board
Wood Handle	1pc
Tempered Glass	Dark Brown
Total Power	4500W
Capacity	5-6 People

Product Characteristics

- High Quality Wood
- Brilliant Lighting
- Infrared Heating
- Intelligent Control
- High Efficiency Heating
- Perfect Accessories

Dimensions

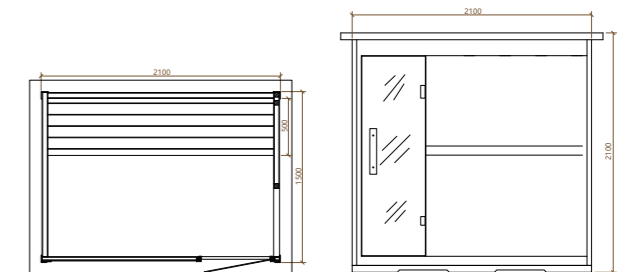

Features



Control System
Equipped with an intelligent control panel that can accurately adjust temperature, humidity, and lighting.



Infrared Heating
The sauna utilizes advanced infrared heating technology, which deeply penetrates the skin for a more effective and soothing experience.



Sauna Speaker
The built-in sauna sound system can play your favorite music or relaxation audio to further enhance the relaxation effect of the sauna.

Wood Colors

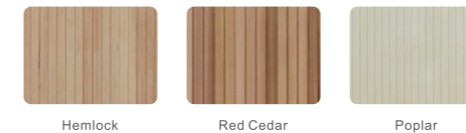

Hemlock

Red Cedar

Poplar

Enhance metabolism

It can resonate with human cells, activate cell activity, improve the metabolic capacity of cells, and promote various biochemical reactions in the body. This helps to expel waste and toxins from the body and strengthen the body's self-repair and regulatory functions.

**A quality life,
carefully selected for you.**

We are constantly upgrading the quality of our excellent saunas,
and this is clearly visible.

Cooperative Partner

From quality to reputation, we continuously empower your success.

...

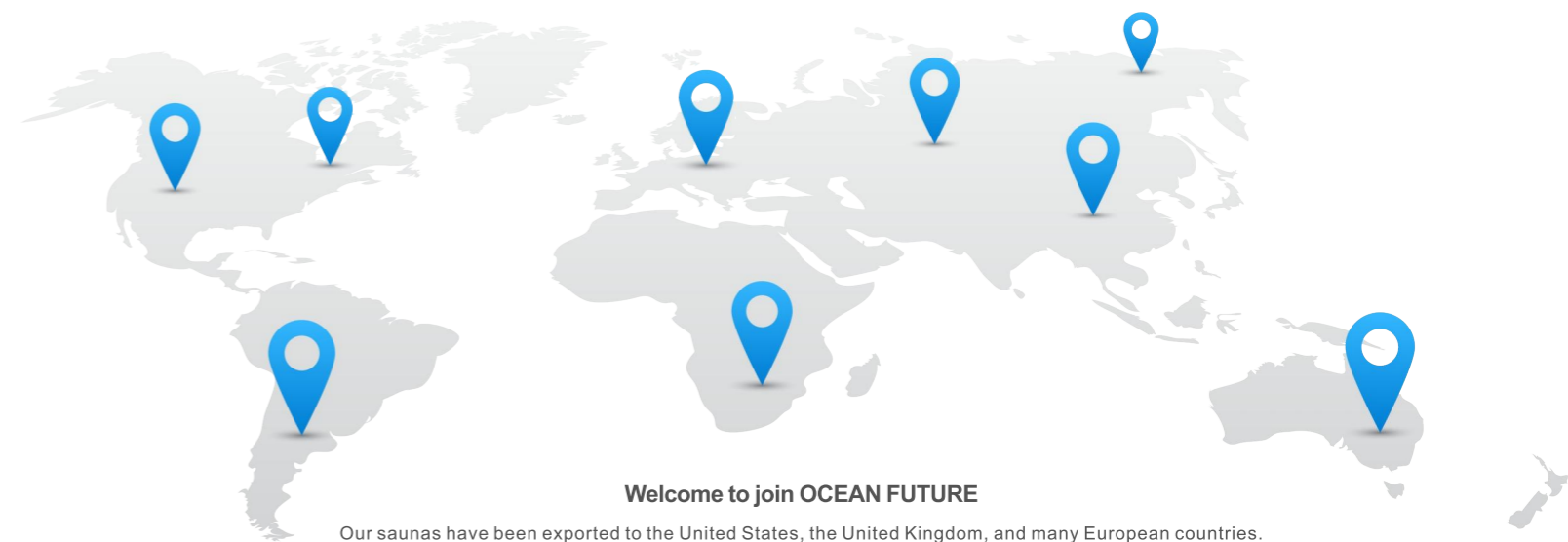

Welcome to join OCEAN FUTURE

Our saunas have been exported to the United States, the United Kingdom, and many European countries.
We hope to support more partners and jointly promote the development of the sauna industry.