



Aluminum Metallized Cardboard Production
One Step Solution Manufacturer

做金卡 找跃达



www.chydjx.com

YUEDA Packing
Machinery



1998

成立于1998年

150

生产能力: 150台/年

Innovation Advances With The Times

创新与时俱进

About YUEDA

关于跃达



实用新型专利: 20+项

外观设计专利: 2项

温州跃达包装机械有限公司座落于中国印刷城温州龙港，集生产、销售、服务为一体的金银卡生产设备制造商。专业生产金银卡纸(复合)涂布机、猫眼定位横切机、高精密双螺旋刀切纸机、全自动、半自动电脑横切机等。我司具有20余年的生产制造历史，拥有雄厚的技术力量，具有高素质的员工和完善的服务，借助市场的反馈信息，加大设备的研发和创新力度，让您使用市场上具有竞争力的金银卡复合及断张裁切设备。公司销售网络遍布全国各地，产品远销东南亚、中东、南美及非洲各地。

以“质量求生存、创新求发展、服务见真诚”是公司的一贯宗旨。质量是信誉的前提，信誉是企业的生命，创新是企业的源泉，服务是企业的竞争力。

Wenzhou Yueda Packaging Machinery Co., Ltd. is located in Wenzhou City Longgang City, the printing city of China, and is a manufacturer of gold and silver aluminum film metallized cardboard production equipment, integrating production, sales and service. We specialize in the production of gold and silver cardboard (laminated) coating machine, cat eye positioning cutting machine, high precision spiral double knife paper cutting machine, automatic and semi-automatic computerized cross cutting machine, etc.. We have more than 20 years of manufacturing history, with strong technical force, high-quality staff and perfect service, with the help of market feedback, increase the research and development of equipment and innovation, so that you can use the market competitive gold and silver card laminating and sheet cutting equipment. The company's sales network is spread all over the country, and products are exported to Southeast Asia, the Middle East, South America and Africa.

Quality for survival, innovation for development, service for sincerity" is the company's consistent purpose. Quality is the premise of reputation, reputation is the life of the enterprise, innovation is the source of the enterprise, service is the competitiveness of the enterprise.

YDLM1300B

龙门式多功能金银卡纸复合(涂布)机-剥离、背涂 Gantry Multifunctional Aluminum Metallized Cardboard Laminating (Coating) Machine

该设备是生产新型包装材料金银卡纸、镀铝转移纸的专用设备，适用于将纸张进行印刷膜、铝箔、镀铝膜、转移镀铝膜进行湿式复合胶水烘干，再背涂接下来转移后再上色或上清油烘干冷却收卷的工艺。

This equipment is a special equipment for the production of new packaging materials gold and silver cardboard and aluminized transfer paper. It is suitable for the process of printing film, aluminum foil, aluminized film, transfer aluminized film for wet composite glue drying, then back coating, then transfer, then coloring or drying cooling and winding with oil.

技术参数 Technical Parameter		YDLM1300B
有效生产宽度	Working width	600-1200mm
机械速度	Machine speed	180m/min
生产速度	Working speed	15-150m/min
基材厚度	Base material	Pet膜 Pet Film: 0.012-0.040mm Opp膜 Opp Film: 0.02-0.06mm 纸 Paper: 100-350g/m ² 铝箔 Aluminum Film: 0.006-0.007mm
复合类型	Laminating type	湿式复合 Water Base Laminate Paperboard
上胶型式	Coating glue type	四辊转移涂布 Four Roller Transfer Coating
背涂、上色型式	Back coating/color type	两辊直接涂布 Anilox Roller Direct Coating
纸放卷直径	Paper Unwinding diameters	1500mm
纸收卷芯直径	Paper Unwinding core dia	3/6/12 inch
收卷直径	Paper rewinding diameter	φ1600mm
收卷芯直径	Paper rewinding core dia	3/6 inch
膜放卷直径	Film unwinding Diameter	600mm
膜收卷芯直径	Film unwinding core dia	3/6 inch
剥离收卷芯直径	Peeling off rewinding diameter	9600mm
剥离收卷芯直径	Peeling off rewinding core dia	3/6 inch
烘道温度	Heating tunnel temperature	±130°C
烘道上部长度	Heating tunnel up part length	15m
烘道下部长度	Heating tunnel down length	8.6m
电源	Power supply	380v±10%, 50hz
动力功率	Motors power	60kw
加热功率	Heating power	216kw
正常生产功率	working power	80kw
外形尺寸	Overall dimensions (L*W*H)	22330mm*3700mm*4600mm
整机重量	Total weight	40t

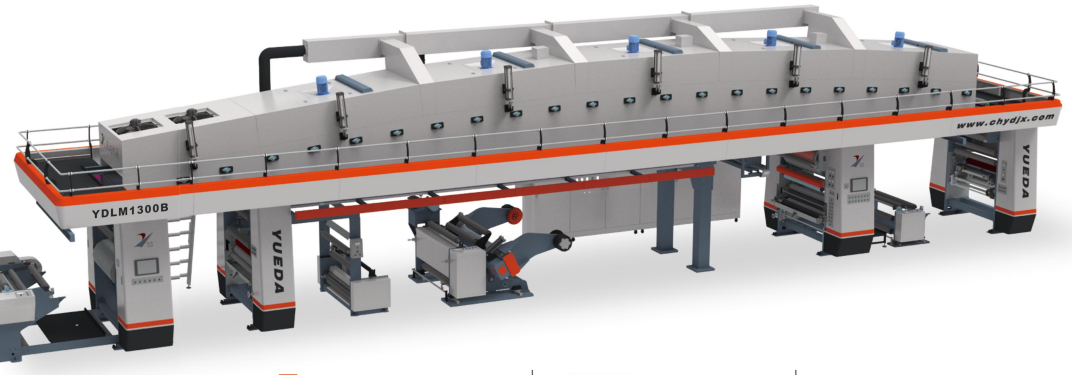
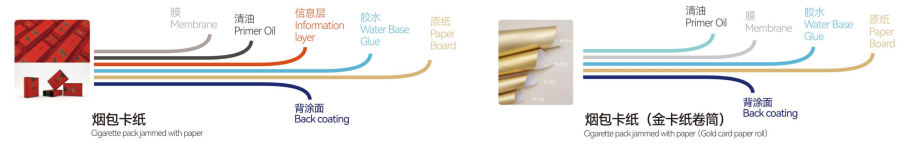

15-150m/min
生产速度
Rate of production



1200mm
有效生产宽度
Effective productive width



平整度好
flatness

ZNFH1300-1400-1500

全自动金银卡纸复合(涂布)机--无轴式收卷

Automatic Aluminum metallized Cardboard Lamintaing & Coating Machine

No Shaft Type Rewinding

该机是为适应现代金银卡纸、镭射材料、烟酒包装材料等包装材料而设计、生产的卧式金银卡纸生产设备。集放卷、涂胶、涂色、干燥、收卷为一体的机型。由进口PLC集中控制，触摸屏显示。是目前工艺完善、性能全、控制先进，是理想的金卡纸复合设备。

A horizontal-type hologram registration embossing equipment special for making high-grade fancy holographic cardboard for different attractive packing products. A combination of film unwinding, glue coating, color coating, heat-blowing and rewinding systems. PLC control and touch-screen for operation; your really optimum choice for fancy registration hologram film manufacture.

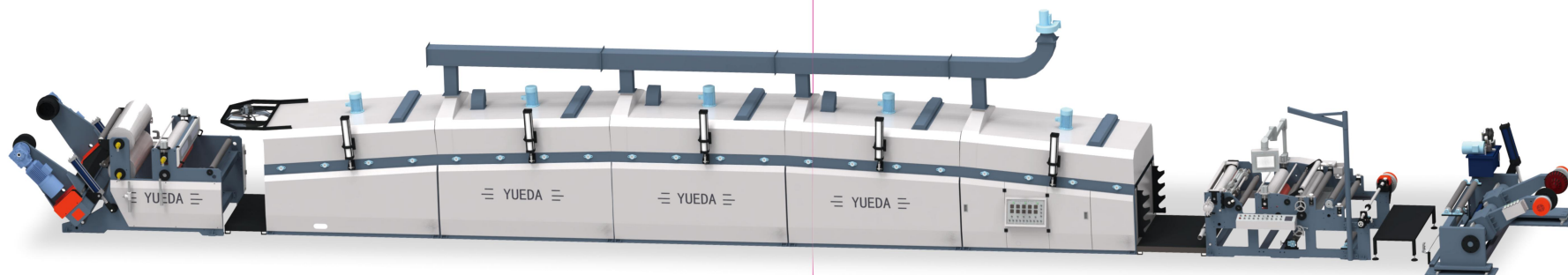

主要工艺参数 Technical Parameter	ZNFH1300	ZNFH1400	ZNFH1500
纸放卷直径 Sheet Roll Dia. At Unwinding Position	100-1600mm		
复合宽度 Sheet Roll Width	600mm-1200mm	700mm-1300mm	700mm-1400mm
纸放卷适用纸芯 Sheet Core Size	3'、6'、12'		
膜(铝粉)直径 Foil (Film) Roll Dia	600mm		
膜(铝粉)放卷管芯 Rewinding Core Size	3'		
纸收卷直径 Rewinding Dia	100-1600mm		
纸收卷管芯 Rewinding Core Size	6-12'		
辊面宽度 Roller Face Width	1300mm	1400mm	1500mm
适用纸张 Suitable Paper	40-400g	40-400g	
适用铝箔(膜)厚度 Applicable Aluminum Foil (Film) Thickness	Aluminum Foil 0.06-0.1mm	Film 0.01-0.1mm	
烘道 Drying Path	125m		
机械速度 Running Speed	5-150m/min		
整机总功率 Total Power Consumption	121kw	126kw	
外形尺寸(长*宽*高) Machine Dimension(L*W*H)	21m*2.9m*3.2m	21m*3.1m*3.2m	21m*3.2m*3.2m

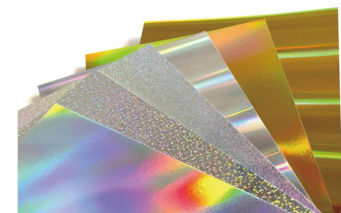

ZNFH1300-1400-1500

全自动金银卡纸复合（涂布）机

Automatic Aluminum Metallized Cardboard Laminating & Coating Machine

该机是为适应现代金银卡纸、镭射材料、烟酒包装材料等包装材料而设计、生产的卧式金银卡纸生产设备。集放卷、涂胶、涂色、干燥、收卷为一体的机型，由进口PLC集中控制，触摸屏显示。是目前工艺完善、性能全、控制先进，是理想的金卡纸复合设备。

A horizontal-type hologram registration embossing equipment special for making high-grade fancy holographic cardboard for different attractive packing products. A combination of film unwinding, glue coating, color coating, heat-blowing and rewinding systems. PLC control and touch-screen for operation, your really optimum choice for fancy registration hologram film manufacture.

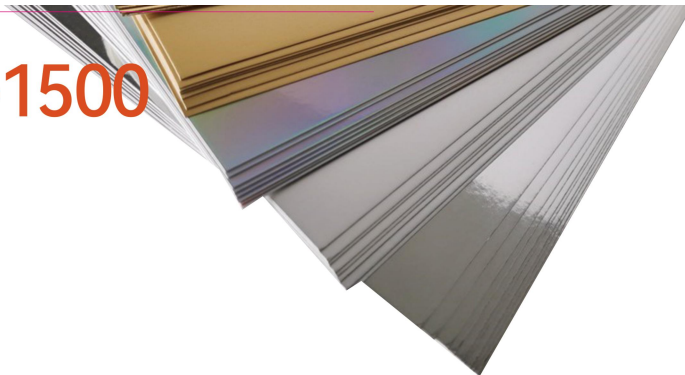

技术参数 Technical Parameter	ZNFH1300	ZNFH1400	ZNFH1500
原卷直径 Sheet Roll Dia. At Unwinding Position	100-160mm		
基色材料宽度 Sheet Roll Width	400mm-1100mm	700mm-1300mm	700mm-1400mm
原卷芯用卷芯 Sheet Core Size	3", 4", 12"		
铝箔（膜）放卷直径 Roll (Film) Roll Dia	400mm		
铝箔（膜）收卷直径 Rewinding Core Size	3"		
收卷直径 Rewinding Dia	100-160mm		
收卷轴直径 Rewinding Core Size	3", 4"		
铝箔宽度 Rollor Face Width	1300mm	1400mm	1500mm
适用铝箔厚度 Foil Thickness	0.00mm-0.05mm		
适用膜厚度 Film Thickness	0.01mm-0.1mm		
适用纸浆厚度 Sheet GSM-weight	40g-450g		
运行最高速度 Running Speed	150m/min		
整机功率 Total Power Consumption	121KW	129KW	
烘道 Heating Oven	125m		
外形尺寸 (长x宽x高) Machine Dimension(LxWxH)	21m*2.8m*3.2m	21m*3.1m*3.2m	21m*3.2m*3.2m

Optional Item 选配项

大辊冷却

Big Roller Cooling Unit
纸张深度冷却
Let The Laminated Paper
Deep Cooling And
Unwrinkle

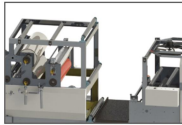

在线剥离

Online Peeling Device

指在纸材做好充分冷却后，转移膜直接剥离开，膜与纸分别收卷。
Use On The Film Cardboard Laminating After Coolingtransfer Film Online
Peeling For The Paper And Film.

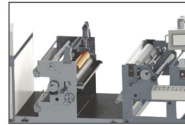

浸版+刮版组合

Immersing + Squeegee Device Unit

浸版上色主要用于涂布厚的材料使用效果
更好
Immersing Color Coating Is More Useful On The
Thicker Ink-Material.

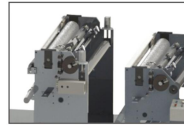

刮版+刮版组合

Squeegee + Squeegee Device Unit

双刮版上色主要方便两种颜色，防止串
墨提高效益
Double Squeegee Device Is For Two Colors Coating
Onthe Material, Is Separate The Colors Mix Effectively
Onthe Material.

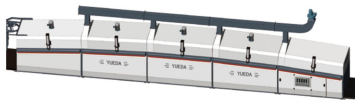

烘箱带摆杆式冷却装置

Heating Oven With The Cooling Pile Roller

减少纸张浪费
Reduce The Papers Wasted.

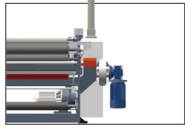

剥离装置

Peeling Device

指在纸材收卷好之后，再把转移膜剥离
Use On The After Rewinding, and Let The Transfer
Film For Peeling.

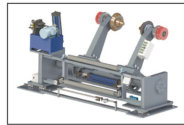

无轴纸架带纠偏功能

Shaft Less With Rectify Device

大批量生产纸张对边方便
More Quantities Cardboard Laminating Produc-
tion Side Correct Easily.

ZNFH Series Production Process 卧式复合机工艺流程

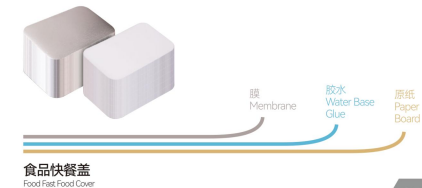
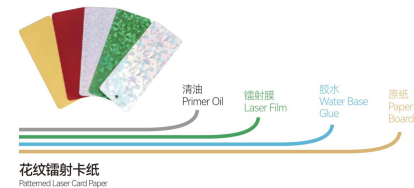
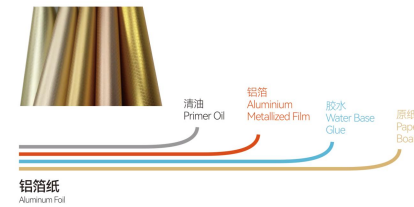

DWLX1300L-1400L

高精度定位双螺旋刀横切机 High Precision Positioning Double Rotary Sheet Cutter Machine

该机适用于裁切猫眼定位卡纸、烟包卡纸、铝箔卡纸、化妆品卡纸等高档包装材料。该机具有液压无轴纠偏放卷，自动张力，卷径到位自动停机，跑位自动停机，自动排废，自动牵引，跟踪误差显示，极限自动停机，斜角度可调，自动叠码，高性能同步伺服牵引，高精度同步伺服切料，德国进口光电检测，自动导标裁切拉规线等功能。

具有裁切拉规线精度高，纸张表面无划痕，裁切后印刷无需修边，纸粉少，操作方便，运行稳定，自动化程度高等优点。该机检品简单，在同类产品中浪费少，误差少，是客户的优选，给您带来市场竞争优势。

技术参数 Technical Parameter	DWLX1400L	DWLX1300L
切纸形式 Cutting type	上下双向螺旋双刀 Double cyclotron size knife up and down	
放卷直径 Unwinding diameter	Φ1600mm	
放料纸管直径 Feeding paper tube diameter	3", 6", 12"	
材料纸管宽度 Material width	400-1400mm	400-1200mm
叠码高度 Stacking height	1500mm	
叠码重量 Stack weight	2000KG	
切纸长度 Cut length	450-1400mm	
空白切面精度 Blank cutting accuracy	±0.1mm	
纵、横双向跟踪精度 Longitudinal and transverse tracking accuracy	±0.1mm	
操作速度 Operating speed	<300mm/min	
裁切速度 Cutting speed	10-40m/min	
气压需求 Barometric demand	0.8mpa	
设计电源 Design power apply	AC380V60Hz	
整机功率 total power	1000W	
整机重量 total weight	15000KG	
外形尺寸(长x宽x高) Overall dimensions (length x width x height)	1355mm x 420mm x 244mm	1345mm x 420mm x 244mm
切刀负载 Cutter load	<550kgm (供参考密度及质量) (density and quality to be considered)	



This machine is suitable for cutting catenary positioning cardboard, cigarette packet cardboard, aluminum foil cardboard, cosmetic cardboard and other high-grade packaging materials. The machine has the functions of hydraulic shaft-less deflection unwinding, automatic tension, automatic stopping of roll diameter in place, automatic stopping of running position, automatic waste discharge, automatic traction, tracking error display, automatic stopping of limit, adjustable slant angle, automatic stacking, high performance synchronous servo traction, high precision synchronous servo cutting material, German imported photoelectric detection, automatic standard finding and cutting of pulling gauge line, etc.

The whole machine is synchronously controlled in front and back, with the advantages of high precision of cutting and pulling gauge line, no scratch on the paper surface, no trimming after cutting and printing, less paper powder, convenient operation, stable operation and high degree of automation. The machine is easy to check the product, easy to operate, less waste and less error among similar products, it is the best choice for customers and gives you a competitive advantage in the market.

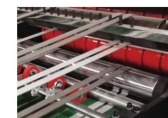

YDSLX1300-1400 高精密度螺旋刀横切机

High Precision Double Rotary Sheet Cutter Machine

该机适用于裁切金银卡纸、烟包卡纸、铝箔卡纸、化妆品卡纸、白板纸、灰板纸、白卡纸等各种卷筒纸材料。该机具有液压无轴纠偏放卷，自动张力，卷径到位自动停机，自动牵引，斜角度可调，自动叠码，高性能伺服牵引，高精度伺服切料。

整机前后同步控制，具有裁切精度高，纸张表面无划痕，纸粉少，操作方便，运行稳定，自动化程度高等优点。该机检品简易，在同类产品中浪费少，误差少，是客户的优选，给您带来市场竞争优势。

The machine is suitable for cutting gold and silver aluminum metallized laminated cardboard, cigarette packet cardboard, aluminium foil cardboard, cosmetic cardboard, white board paper, grey board paper, white cardboard and other various roll materials. The machine has hydraulic shaft-less deflection unwinding, automatic tension, automatic stop when the roll diameter is in place, automatic traction, adjustable slant angle, automatic stacking, high performance servo traction, high precision servo cutting.

The whole machine is synchronized with front and Edge side control, which has the advantages of high precision of cutting and pulling gauge line, no scratch on paper surface, less paper powder, easy operation, stable operation and high degree of automation. The machine is easy to check the product, less waste and less error among similar products, it is the best choice for customers and gives you a competitive advantage in the market.



无纸毛、少纸粉、无翻边
No paper wool, no paper powder, no flanging



切口平整
Notch leveling

技术参数 Technical Parameter	YDSLX1400	YDSLX1300
切纸形式 Cutting type	上下300度螺旋刀 Double cycloid screw knife up and down	
放卷直径 Unwinding diameter	φ1650mm	
放料纸筒直径 Feeding paper tube diameter	3"、6"、12"	
纸幅宽度 Material width	400-1400mm	400-1250mm
叠码高度 Stacking height	1500mm	
叠码重量 Stack weight	2000KG	
切纸长度 Cut length	400-1400mm	
空白切纸精度 Blank cutting accuracy	±0.1mm	
操作速度 Operating speed	≤300m/min	
裁切速度 Cutting speed	10-400m/min	
气压需求 Barometric demand	0.8mpa	
设计电源 Design power supply	AC380V50Hz	
整机功率 Total power	73kW	
整机重量 Total weight	12000KG	
外形尺寸(长x宽x高) Overall dimensions (length x width x height)	9.6m* 4.68m* 2.58m	9.6m* 4.53m* 2.58m
切刀负载 Cutter load	≤500g/m (需考虑密度及质量) (density and quality to be considered)	

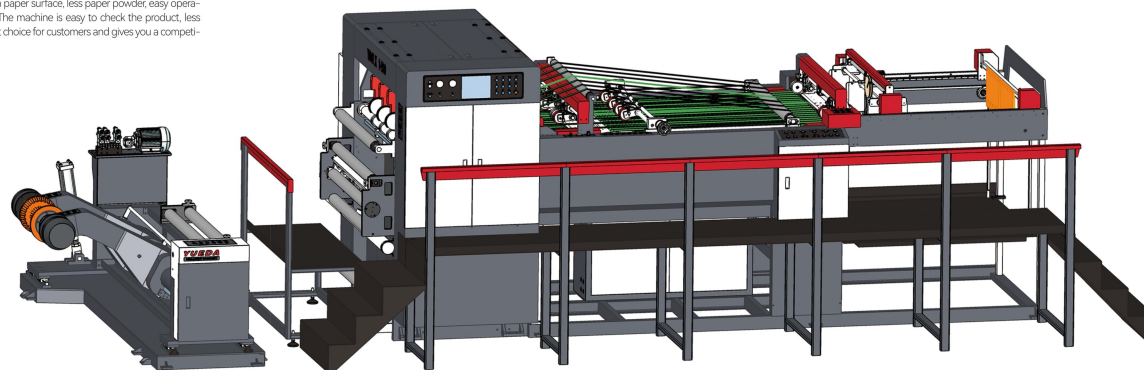

YD1300-1400 定位横切机 (无轴)

Positioning Sheeter (Shaft-less)

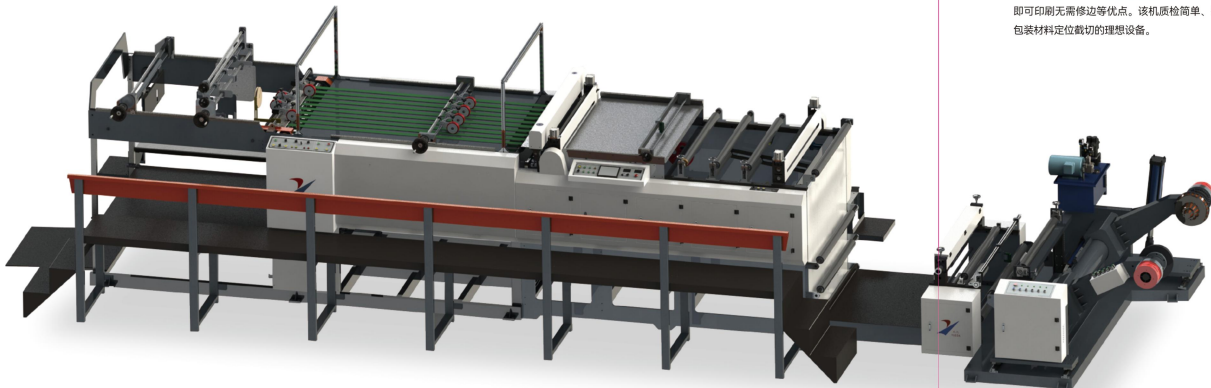

该机适用于裁切猫眼定位卡纸、烟包卡纸、镭射卡纸、铝箔卡纸、化妆品卡纸等高档包装材料。该机具有液压放卷、自动张力、放卷无料自动停机、自动定位在线修边、自动排废、自动牵引、原距误差极限自动报警停车、菱形角度可调、纸张同步输送、自动叠码、高性能变频牵引、高精度同步伺服送料、高灵敏度光电自动寻标裁切拉线等。采用彩色触摸屏、PLC集中控制，具有运行稳定、定位裁切拉线精度高、纸张表面无划痕、切后即可印刷无需修边等优点。该机质检简单、操作方便是高档印刷包装材料定位裁切的理想设备。

Special for sheeting cardboard like the multi-lens sheet with sensor-mark for sheeting in position, cardboard for cigarette pack, cardboard of hologram/golden/silver film laminated type, aluminum-foil laminated type, or cardboard for cosmetics pack. A combination of hydraulic unwinding, auto tension control, auto stop while idle unwinding happens, auto on-line trimming in position, auto discharging, auto traction, auto alarm and stop while the limit of error allowance on sheet size breaks, sheeting angle adjustment, auto stacking, high-performance frequency-converting traction, high-accuracy synchronous servo feeding, and high-sensitivity German tracking and testing system for auto sensor tracking and registration for sheeting. Moreover, it features imported touch screen, high-accuracy synchrony controller, and high-efficiency PLC controller, ensuring the high-automation performance, easy operation, high precision for sheeting position, no scratching on sheet surface, and no trimming necessary after sheeting that's suitable for direct printing after sheeting. Being so high in precision, easy in quality control and labor-saving, it's the optimum choice for high-grade printing and packing business.

技术参数 Technical Parameter		YD1300	YD1400
滚卷直径	Max. Sheet Roll Dia.	1600mm	
材料宽度	Sheet Roll Width	700-1200mm	700-1300mm
裁切负载	Gram-weight For Sheeting	400g	
裁切精度	Sheeting Accuracy	±0.1mm	
裁切长度	Sheeting Length	400mm-1200mm	
叠码高度	Stacking Height	1300mm	
裁切速度	Running Speed	95m/min	90m/min
机械车速	Mechanical Sheeting Speed	140sheet/min	
气压需求	Pneumatic Pressure	0.8mpa	
设计电源	Power Supply	AC380V/50Hz	
整机功率	Total Power Consumption	17.9kW	20kW
外形尺寸(长x宽x高) Machine Dimension(L*W*H)		11.2m*3.14m*2.4m	11.2m*3.24m*2.4m
整机重量	Machine Weight	8000kg	8500kg



YD1300-1400 定位横切机 (有轴)

Positioning Sheeter (With Shaft)



该机适用于裁切猫眼定位卡纸、烟包卡纸、镭射卡纸、铝箔卡纸、化妆品卡纸等高档包装材料。该机具有液压放卷、自动张力、放卷无料自动停机、自动定位在线修边、自动排废、自动牵引、版距误差极限自动报警停车、菱形角度可调、纸张同步输送、自动叠码、高性能变频牵引、高精度同步伺服送料、高灵敏度德国进口光电自动寻标裁切拉线等功能。采用彩色触摸屏操作、高效能PLC集中控制，具有自动化程度高、操作方便、运行稳定、定位裁切拉线精度高、纸张表面无划痕、切后即可印刷无需修边等优点。该机是目前精度高、质检简单、操作方便是高档印刷包装材料定位裁切最佳设备。

Special for sheeting cardboard like the multi-lens sheet with sensor-mark for sheeting in position, cardboard for cigarette pack, cardboard of hologram/goldensilver film laminated type, aluminum-foil laminated type, or cardboard for cosmetics pack. A combination of hydraulic unwinding, auto tension control, auto stop while idle unwinding happens, auto on-line trimming in position, auto discharging, auto traction, auto alarm and stop while the limit of error allowance on sheet size breaks, sheeting angle adjustment, auto stacking, high-performance frequency-converting traction, high-accuracy synchronous servo feeding, and high-sensitivity German tracking and testing system for auto sensor tracking and registration for sheeting. Moreover, it features imported touch screen, high-accuracy synchrony controller, and high-efficiency PLC controller, ensuring the high-automation performance, easy operation, high precision for sheeting position, no scratching on sheet surface, and no trimming necessary after sheeting that's suitable for direct printing after sheeting. Being so high in precision, easy in quality control and labor-saving, it's the optimum choice for high-grade printing and packing business.

技术参数 Technical Parameter	YD1300	YD1400
放卷直径 Max. Sheet Roll Dia	1600mm	
材料宽度 Sheet Roll Width	700-1200mm	700-1300mm
裁切负载 Gem-weight for Sheeting	600g/m	
裁切精度 Sheeting Accuracy	±0.1mm	
裁切长度 Sheeting Length	400mm-1200mm	
叠码高度 Stacking Height	1300mm	
叠码速度 Running Speed	95m/min	90m/min
机械车速 Mechanical Sheeting Speed	1425sheet/min	
气源压力 Pneumatic Pressure	0.6MPa	
设计电源 Power Supply	AC380V/50Hz	
整机功率 Total Power Consumption	14.9kW	19kW
外形尺寸(长*宽*高) Machine Dimension(L*W*H)	11.2m*3.14m*2.6m	11.2m*3.24m*2.6m
整机重量 Machine Weight	8000kg	8500kg



YDBL1300-1400 定位横切机(剥离)

Positioning Sheeter (Peeling Off)

该机适用于裁切猫眼定位卡纸、烟包卡纸、镭射卡纸、铝箔卡纸、化妆品卡纸等包装材料。该机具有液压放卷、自动张力、放卷无料自动停机、自动剥离收卷、自动定位在线修边、自动排废、自动牵引、版距误差超限自动报警停车、菱形角度可调、自动纸张运输、自动叠码、高性能变频牵引、高精度同步伺服拉料、高灵敏度光电自动寻标裁切拉提线等。采用彩色触摸屏、同步控制、PLC集中控制，具有自动化程度高、运行稳定、定位裁切拉提线精度高、纸张表面无划痕、裁切后即可印刷无需修边等优点。该机精度高、质检简单、使用方便是印刷包装材料定位裁切佳选设备。

Special for sheeting cardboard like the multi-lens sheet with sensor-mark for sheeting in position, cardboard for cigarette pack, cardboard of hologram/golden/silvery film laminated type, aluminum-foil laminated type, or cardboard for cosmetics pack. A combination of hydraulic unwinding, auto tension control, auto stop while idle unwinding happens, auto peeling and rewinding, auto on-line trimming in position, auto discharging, auto traction, auto alarm and stop while the limit of error allowance on sheet size breaks, sheeting angle adjustment, auto sheet feeding and stacking, high-performance frequency-converting traction, high-accuracy synchronous servo feeding, and high-sensitivity German tracking and testing system for auto sensor tracking and registration for sheeting. Moreover, it features imported touch screen, high-accuracy synchrony controller, and high-efficiency PLC controller, ensuring the high-automation performance, easy operation, stable running, high precision for sheeting position, no scratching on sheet surface, and no trimming necessary after sheeting that's suitable for direct printing after sheeting. Being so high in precision, easy in quality control and labor-saving, it's the optimum choice for high-grade printing and packing business.

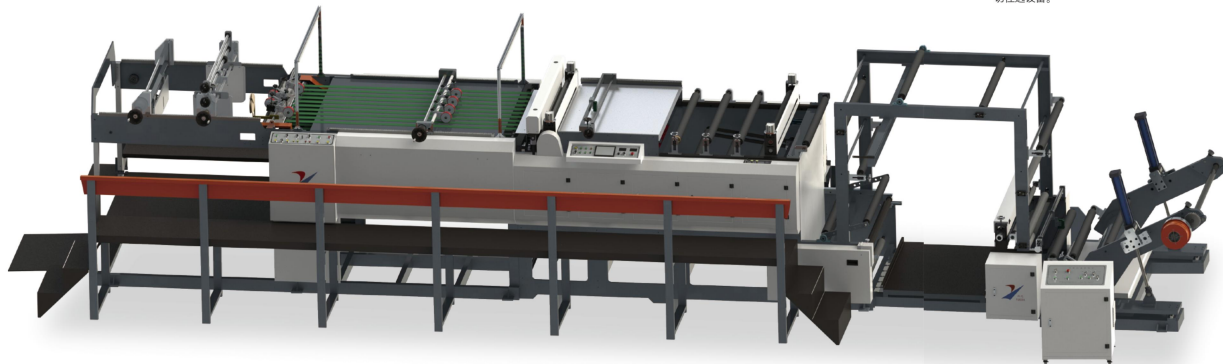

技术参数 Technical Parameter	YDBL1300	YDBL1400
放卷直径 Max. Sheet Roll Dia	1600mm	
膜剥离收卷直径 Film Roll Diameter after Peeling and Rewinding	600mm	
材料宽度 Max. Sheet Roll Width	700-1200mm	700-1300mm
裁切负载 Max. Gram-weight for Sheeting	600gm	
裁切精度 Sheeting Accuracy	±0.1mm	
裁切长度 Sheeting Length	400mm-1200mm	
叠码高度 Stacking Height	1500mm	
裁切速度 Running Speed	95m/min	90m/min
机械车速 Mechanical Sheeting Speed	1420meters/min	
气压需求 Pneumatic Pressure	0.8mpa	
设计电源 Power Supply	AC380V/50Hz	
整机功率 Total Power Consumption	195kW	230kW
外形尺寸(长*宽*高) Machine Dimension(L*W*H)	12m*3.14m*2.4m	12m*3.24m*2.4m
整机重量 Machine Weight	8500kg	9000kg

YDH1300-1400 横切机

Sheet Cutting Machine

该机适用于裁切烟包卡纸、镭射卡纸、铝箔卡纸、化妆品卡纸等包装材料。该机具有液压无轴式放卷、自动张力、放卷无料自动停机、菱形角度可调、纸张同步输送、自动叠码、高性能变频牵引等。采用彩色触摸屏、PLC集中控制，具有自动化程度高、运行稳定、纸张表面无划痕等优点。该机精度高、质检简单、使用方便是印刷包装材料裁切的理想设备。

Special for sheeting cardboard for cigarette pack, cardboard of hologram/golden/silvery film laminated type, aluminum-foil laminated type, or cardboard for cosmetics pack. A combination of hydraulic unrolling system, auto tension control system, auto stop system for idle unrolling, sheeting angle adjustment system, synchronous feeding and discharging system, auto stacking system, and high-performance frequency-converting traction system. Moreover, it features imported touch screen and high-efficiency PLC controller, ensuring the high-automation performance, easy operation, stable running, and no scratching on sheet surface. Being so high in precision, easy in quality control and labor-saving, it's the optimum choice of paper sheeting for the high-grade printing and packing business.

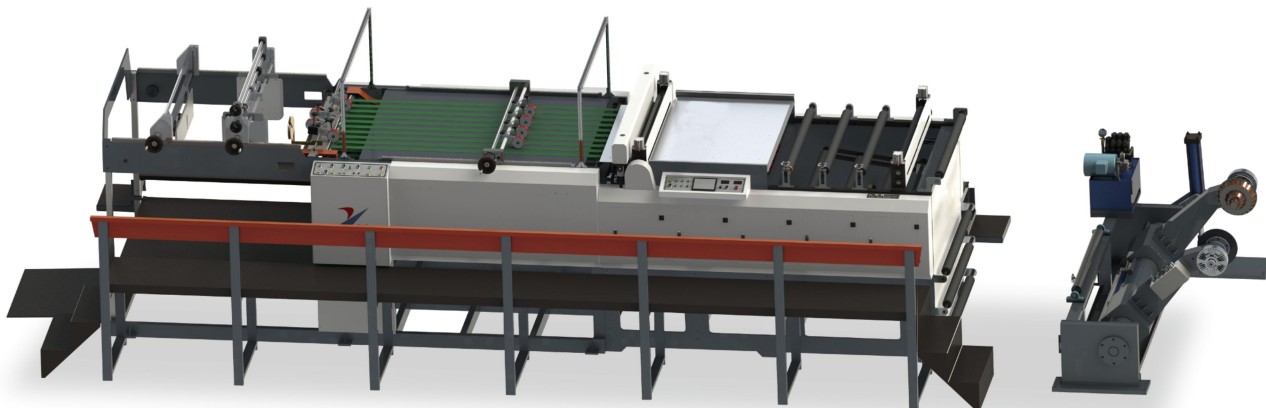

技术参数 Technical Parameter	YDH1300	YDH1400
放卷直径 Max. Sheet Roll Dia	1600mm	
材料宽度 Sheet Roll Width	700-1200mm	700-1300mm
裁切负载 Gram-weight for Sheeting	600g/m	
裁切精度 Sheeting Accuracy	±0.2mm	
裁切长度 Sheeting Length	400mm-1200mm	
叠码高度 Stacking Height	1300mm	
裁切速度 Running Speed	95m/min	90m/min
机械车速 Mechanical Sheeting Speed	140sheet/min	
气压需求 Pneumatic Pressure	0.8mpa	
设计电源 Power Supply	AC380V/50Hz	
整机功率 Total Power Consumption	195W	
外形尺寸(长x宽x高) Machine Dimension(L*W*H)	11.2m*3.14m*2.4m	11.2m*3.24m*2.4m
整机重量 Machine Weight	8000kg	8600kg

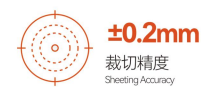

FQN1200/1400

横切机 (升高型)
Transverse Cutting Machine
(Elevation Type)

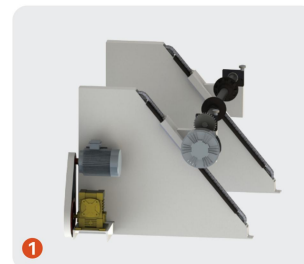

该机适用于白板纸、灰板纸、白卡纸、牛皮纸、玻璃卡纸、特种纸、铝箔纸及各种卷筒材料横向裁切。电器配置部分采用先进的工业控制器，彩色触摸屏，变频器，伺服电机驱动，整机控制方式先进，将主机、伺服电机、送料电机三者的速度通过控制器集中控制，达到同步运行。具有裁切精度高，浪费少，速度快，上料方便等优点。

This machine applies to transverse cutting for white board, grey board, ivory board, kraft paper, cast coating cardboard, specialty paper, aluminum paper and various coiling block material. Configuration part of electrical equipment adopts international advanced industrial controller, color touch screen, transducer, and servo motor drive. The complete machine has advanced control mode, which intensively controls the speed of host machine, electrical machine for material feeder to achieve synchronous operation. It has advantages of highly accurate cutting, little to waste, fast speed, convenience for material loading, etc.

技术参数 Technical Parameter	FQN1200	FQN1400
裁切宽度 Cutting Width	1200mm	1400mm
裁切长度 Cutting Length	400-1300mm	
进纸板高度 Paper-piling height	1300mm	
裁切厚度 Cutting Thickness	0-500g	
裁切精度 Cutting Precision	±0.2mm	
裁切速度 Cutting Speed	95m/min	90m/min
放料直径 Feeding Diameter	160mm	
总功率 Total Power	8.3kw	9kw
外形尺寸(长*宽*高) Overall Dimension(L*W*H)	6000*2200*2350mm	6000*2400*2350mm



95m/min
生产速度
Rate of production



±0.2mm
裁切精度
Sheeting Accuracy

Wenzhou YUEDA Packing
Machinery Co., Ltd.
温州跃达包装机械有限公司

www.chydjx.com

 浙江省温州市龙港市时代大道1333号2号楼
Building 2, No.1333 Times Avenue, LonggangCity,
Wenzhou City,Zhejiang Province China

TEL: 0577-64192299
MOB: 135 6622 1000 187 6745 8866
E-mail: peterchen@yuedamachine.com



YOUTUBE



抖音



微信视频号
